

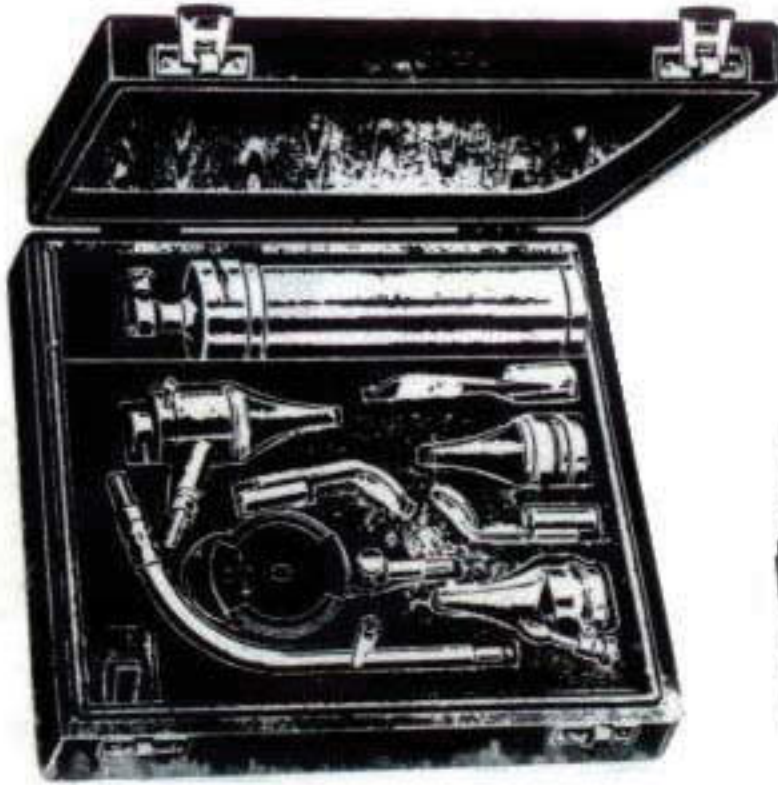

DIAGNOSTIC SETS

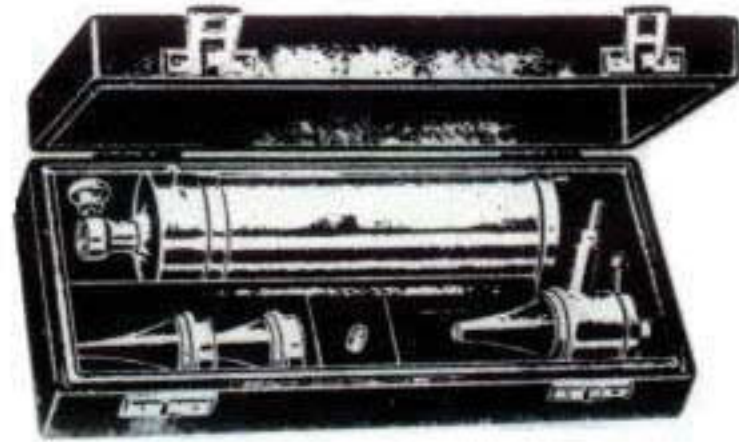

UNIVERSAL SET
1-100



OTOSCOPE SET
1-110

BLOOD LANCETS



FRANCKE
1-120



FRANCKE
1-130

CHEST PIECES



BOWLES
1-140



BOWLES
1-150



DIAGNOSTICS

CHEST PIECES AND STETHOSCOPES

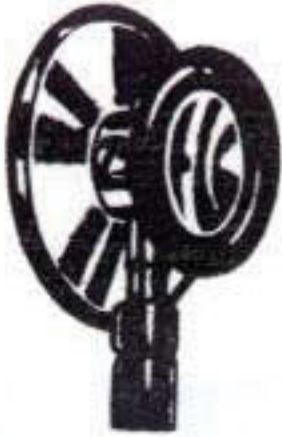

LIGHTWEIGHT
1-160



SPRAGUE-BOWLES
1-170



BOWLES
1-180



FORD
1-190



BELL-END
1-200



SPARE RUBBER
1-210



DIAPHRAM
1-220

FRAMES



HEAD FRAME
FOR LIGHTWEIGHT
1-230

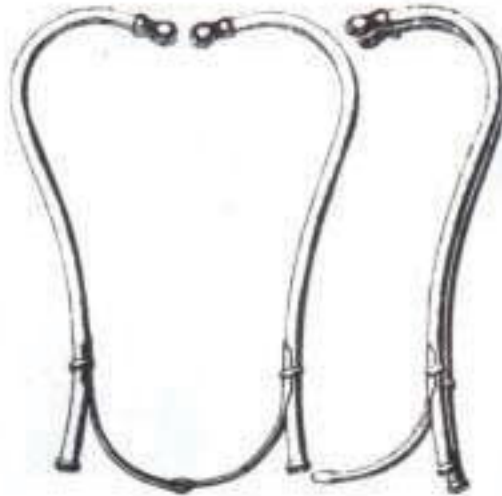

HEAD FRAME
FOR BINURAL
1-240



PINARD
1-250 ALUMINIUM
1-260 WOODEN



DIAGNOSTICS
STETHOSCOPES



BOWLES
1-270

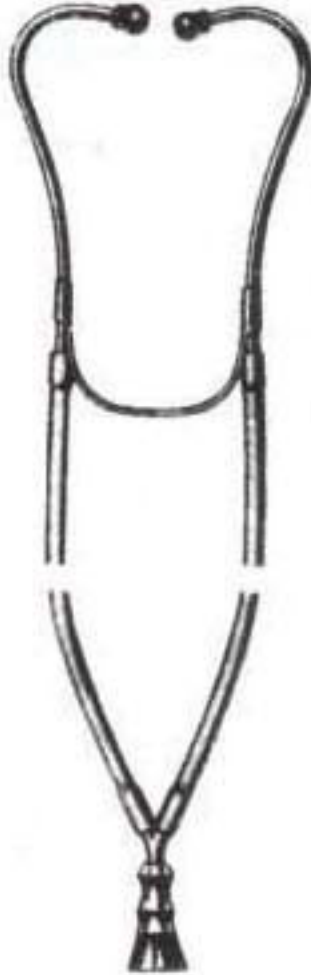

FORD
1-280



FORD-BOWLES
1-290

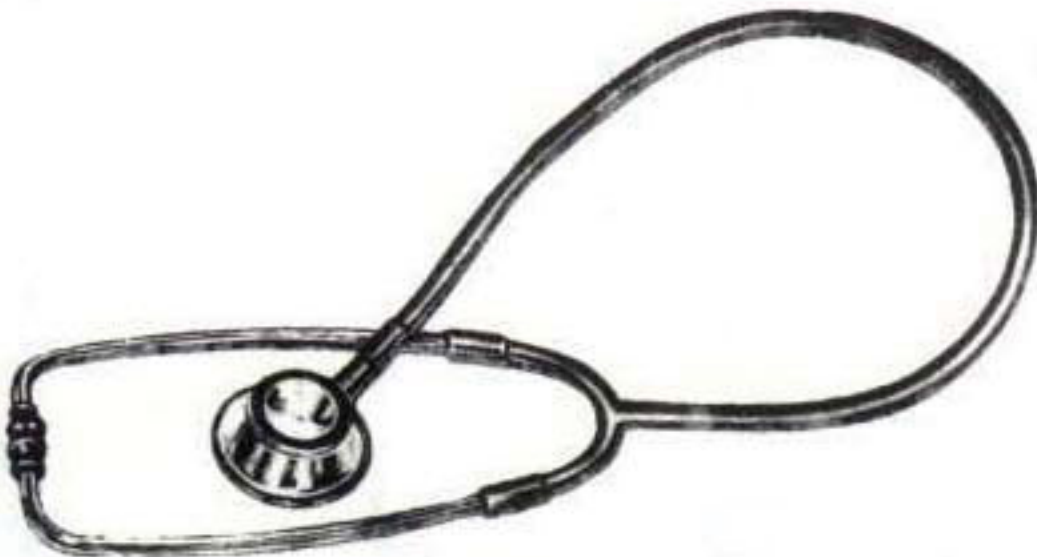

LIGHTWEIGHT
1-300



DIAGNOSTICS

PERCUSSION HAMMERS



TAYLOR
1-310 19 cm



DEJERINE
1-320 20 cm



DEJERINE
1-330



BABINSKY
1-340

PINWHEEL



WARTENBERG
1-380

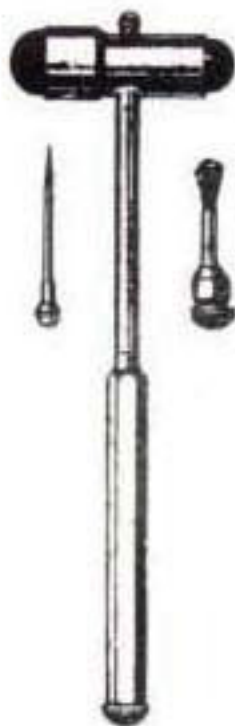

BUCK
1-350 18 cm



BERLINER
1-360



TRAUBE
1-370



ANAESTHESIA

INHALERS



SCHIMMELBUSCH
3-100 ADULT
3-102 CHILD



YANKAUER
3-120 ADULT
3-122 CHILD

AIRWAYS



CONNELL
3-130 ADULT
3-132 CHILD

CATHETER INTRODUCING FORCEPS



MAGILL
3-140 24 cm
3-142 20 cm

LARYNGOSCOPES

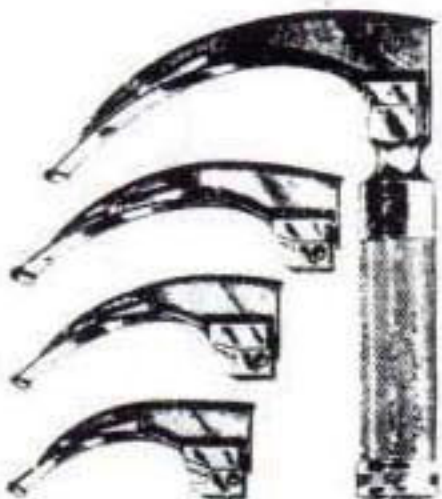

McINTOSH
3-150

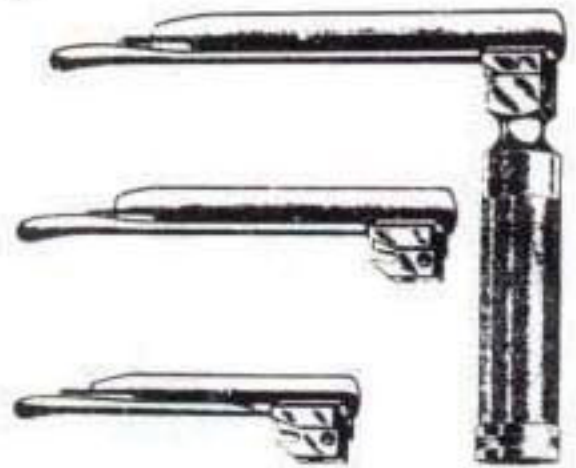

MEGUS
3-160



PUNCTURE TROCARS ABDOMINAL

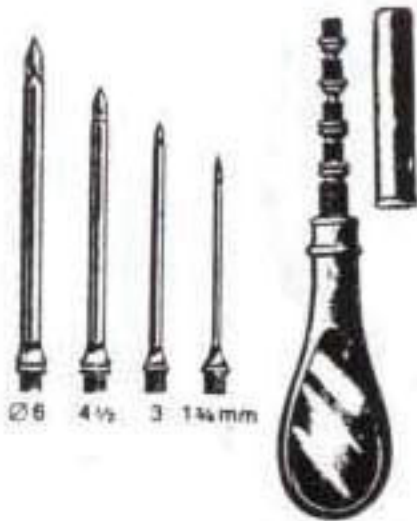

Ø 6 4 1/2 3 1 3/4 mm

UNIVERSAL
5-100 SET OF 4



UNIVERSAL
5-110 SET OF 4

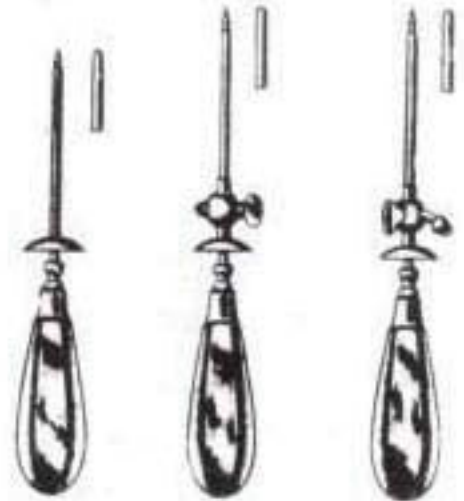

ABDOMINAL

| | | |
|-------------|-------------|-------|
| 5-120 3 mm | 5-130 3 mm | 5-140 |
| 5-121 3.5mm | 5-131 3.5mm | 5-141 |
| 5-122 4 mm | 5-132 4 mm | 5-142 |
| 5-123 4.5mm | 5-133 4.5mm | 5-143 |
| 5-124 5 mm | 5-134 5 mm | 5-144 |
| 5-125 5.5mm | 5-135 5.5mm | 5-145 |
| 5-126 6 mm | 5-136 6 mm | 5-146 |



NELSON
5-150 25 Fg.
5-152 30 Fg.
5-154 33 Fg.
5-156 35 Fg.



FLEURANT
5-160



FLEURANT
5-170



HYDROCELE
5-180 8 Fg.
5-182 9 Fg.
5-184 10 Fg.



ASCITES
5-190 16 Fg.
5-192 21 Fg.



**PUNCTURE
TROCARS ABDOMINAL**



KRAUSE
5-200 5,5mm ϕ



LICHWITZ
5-210 1,75mm ϕ



OCHSNER
5-220 10Fg.
5-221 12Fg.
5-222 14Fg.

**ASPIRATION
SUCTION TUBES**



POOLE
5-230 30 Fg



POOLE
5-240 30 Fg



YANKAUERE
5-250



GENERAL INSTRUMENTS

HANDLES

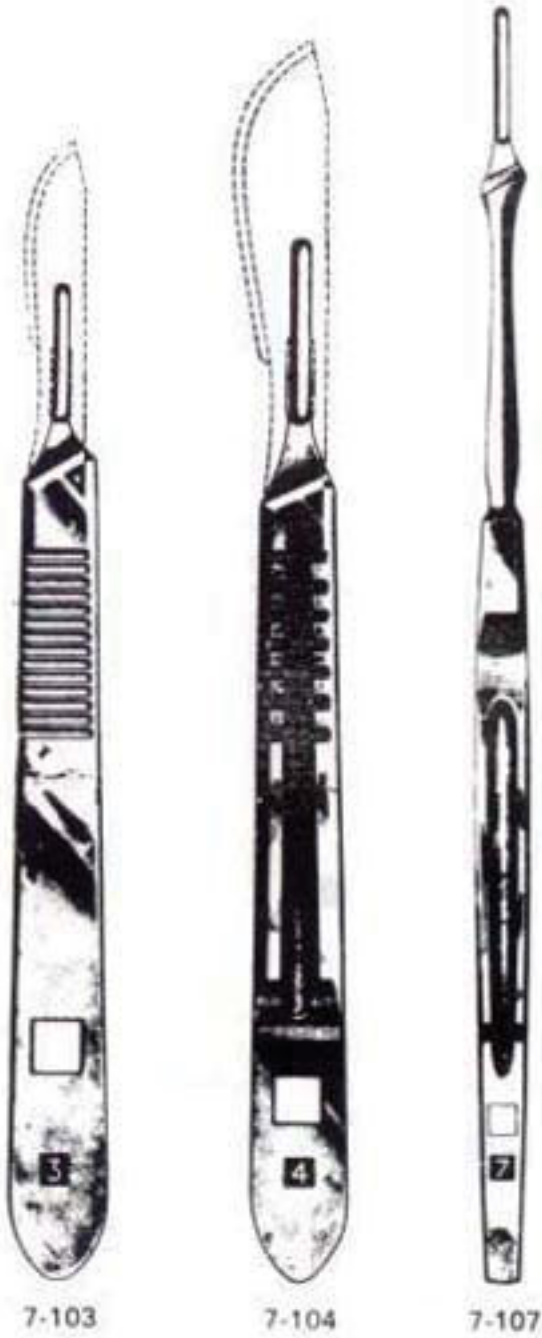

SCALPELS



7-150
Fig. 1 to 18

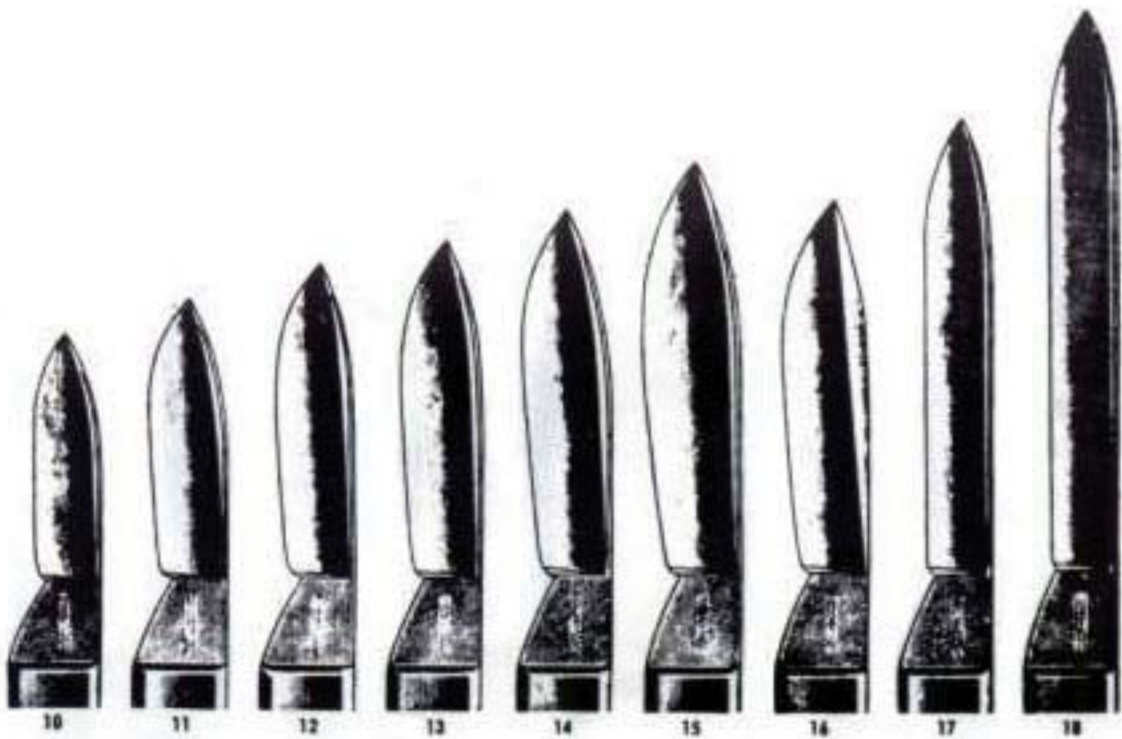
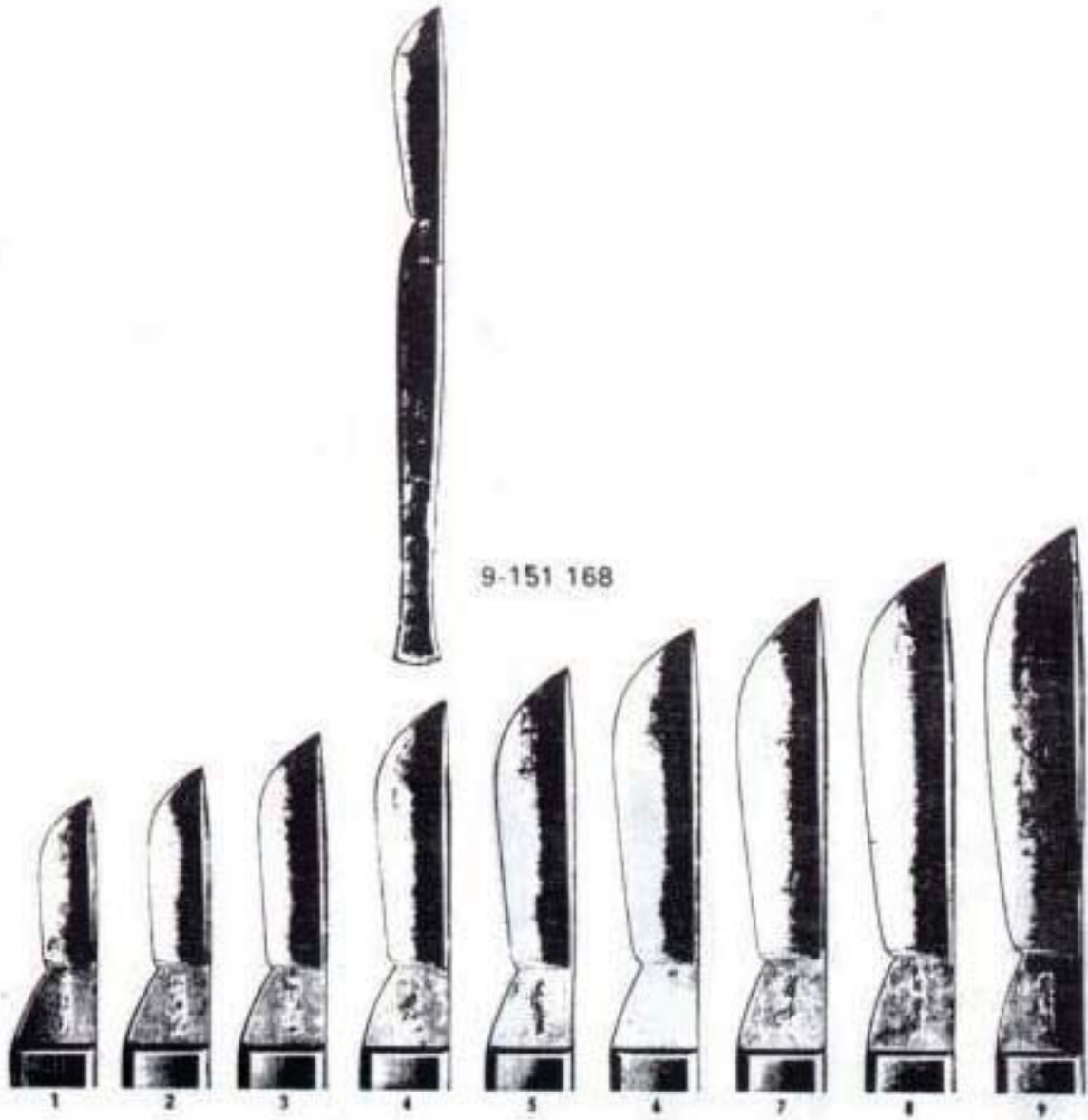



GENERAL INSTRUMENTS
SCALPELS



COLLIN
9-171/188



Fig 1



2



3



4



5



6



7



8



9



10



11



12



13



14



15



16



17



18



**GENERAL INSTRUMENTS
KNIVES**



LANGENBECK AMPUTATIO-
9-190 Blade 12cm



LISTON AMPUTATION
9-200 Blade 17, 20cm



AMPUTATION
9-210
Blade 13, 16, 18, 22cm



CATLIN
9-220
Blade 18, 19, 22cm



BRAIN
9-230
Blade 20, 22cm



RAZOR
9-240



GENERAL INSTRUMENTS DISSECTING SETS

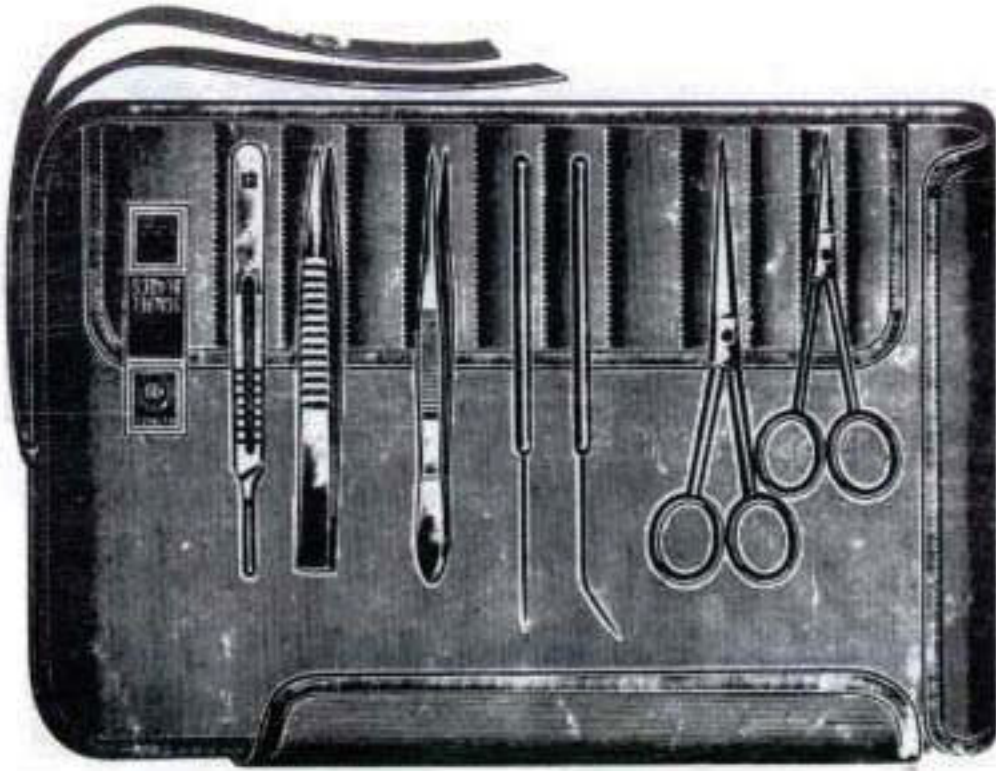

11-100

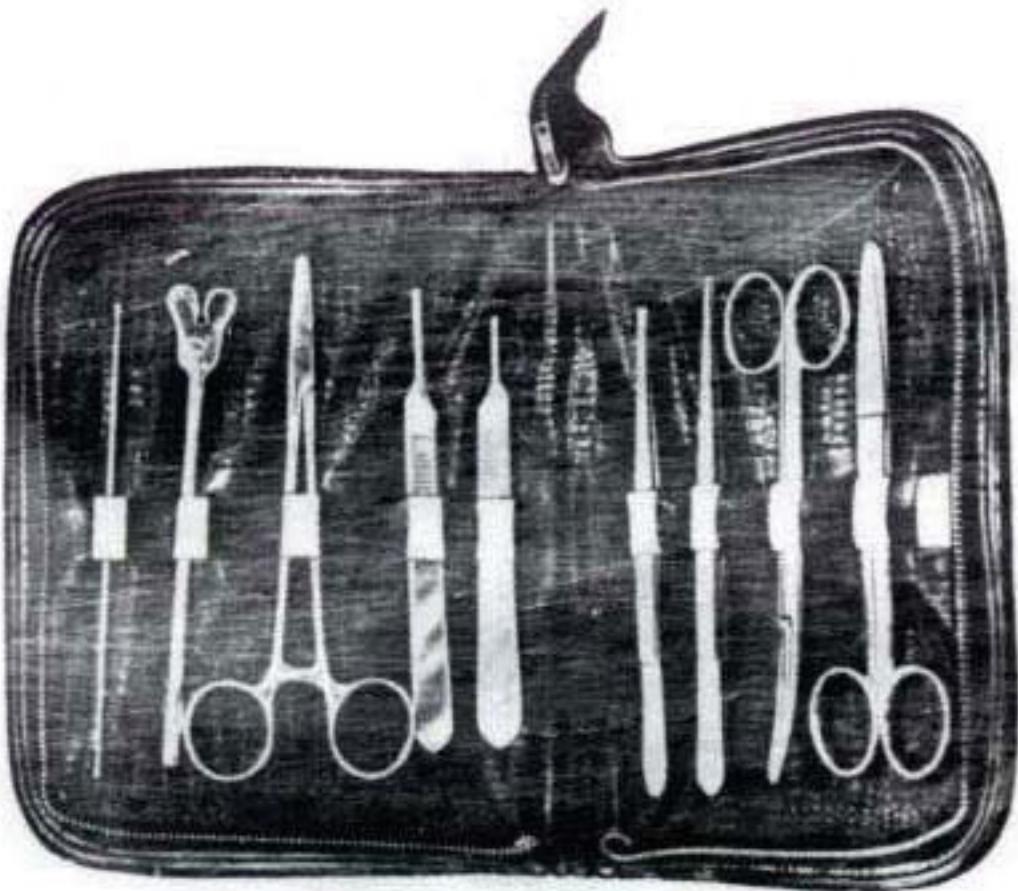

11-120



GENERAL INSTRUMENTS OPERATING SCISSORS



OPERATING



13-100 13cm
13-102 14cm
13-104 15cm
13-106 17.5cm
13-108 20cm



13-110 13cm
13-112 14cm
13-114 15cm
13-116 17.5cm
13-118 20cm



13-120 13cm
13-122 14cm
13-124 15cm
13-126 17.5cm
13-128 20cm



13-130 13cm
13-132 14cm
13-134 15cm
13-136 17.5cm
13-138 20cm



13-140 13cm
13-142 14cm
13-144 15cm
13-146 17.5cm
13-148 20cm



13-150 13cm
13-152 14cm
13-154 15cm
13-156 17.5cm
13-158 20cm



INCISION
13-160 13cm
13-162 14cm



DEAVER
13-170 14cm



13-172 14cm

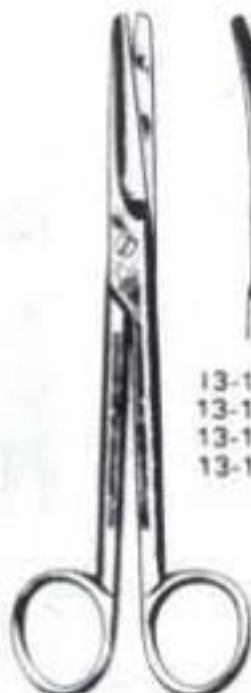

MAYO
13-180 14cm
13-182 15cm
13-184 17cm
13-186 23cm



13-190 14cm
13-192 15cm
13-194 17cm
13-196 23cm

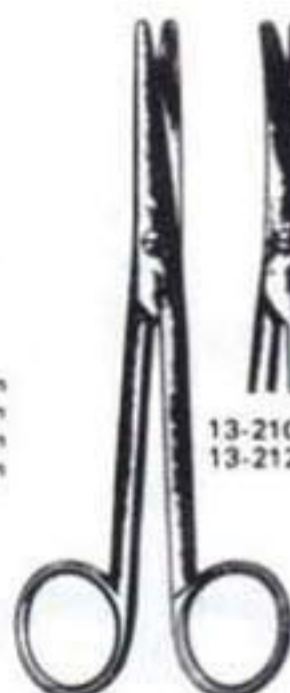

MAYO STILLE
13-200 15cm
13-202 17cm



13-210 15cm
13-212 17cm



GENERAL INSTRUMENTS OPERATING SCISSORS



LEXER
13-220 16cm

PLASTIC SURGERY SCISSORS



LEXER
13-222 16cm



METZENBAUM
13-224 14cm
13-226 15cm
13-228 18cm
13-230 20cm



13-232 14cm
13-234 15cm
13-236 18cm
13-238 20cm



METZENBAUM-NELSON
13-240 18cm
13-242 20cm
13-244 23cm
13-246 25cm
13-248 28cm



13-250 18cm
13-252 20cm
13-254 23cm
13-256 25cm
13-258 28cm



JOSEPH
13-260 14cm



13-262 14cm

NEURO SCISSORS



KILNER
13-270 12cm



McINDOE
13-280 19cm

TONSIL SCISSORS



STRULLY
13-290 22cm



GENERAL INSTRUMENTS

TONSIL SCISSORS



YANKAUER
13-300 17.5cm



13-312 17cm

DEAN
13-310 17cm

NAZAL SCISSORS



HEYMAN
13-320 18cm

NAZAL SCISSORS



BECKMAN
13-330 19cm

LIGATURE SCISSORS



SPENCER
13-340 9cm



SPENCER
13-350 13cm



LITTAUER
13-360 14cm



LIGATURE & WIRE SCISSORS



HEATH
13-370 15cm



UNIVERSAL
13-380 12cm



SCHOEMAKER
13-390 14.5cm

UMBILICAL SCISSORS

EPISITOMY SCISSORS



BRAUN-STADLER
13-400 14.5cm
13-402 22 cm



BUSCH
13-410 16cm



BUSCH
13-420 16cm



U.S.A. PATT.
13-430 10.5cm
13-432 12.5cm



DISSECTING SCISSORS



13-442 11.5cm

DISSECTING
13-440 11.5cm



13-460 11.5cm
13-462 12.5cm
13-464 14 cm

DISSECTING
13-450 11.5cm
13-452 12.5cm
13-454 14 cm

UTERINE SCISSORS



13-472 17.5cm

DOYEN
13-470 17.5cm

UTERINE SCISSORS

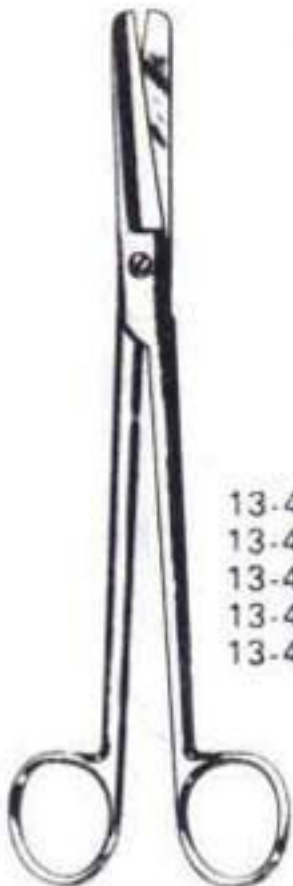

SIMS



| | | | |
|---------------|---------------|---------------|--------|
| 13-480 19 cm | 13-490 19 cm | 13-500 19 cm | 13-510 |
| 13-482 20 cm | 13-492 20 cm | 13-502 20 cm | 13-512 |
| 13-484 21.5cm | 13-494 21.5cm | 13-504 21.5cm | 13-514 |
| 13-486 23 cm | 13-496 23 cm | 13-506 23 cm | 13-516 |
| 13-488 24 cm | 13-498 24 cm | 13-508 24 cm | 13-518 |

FISTULA SCISSORS

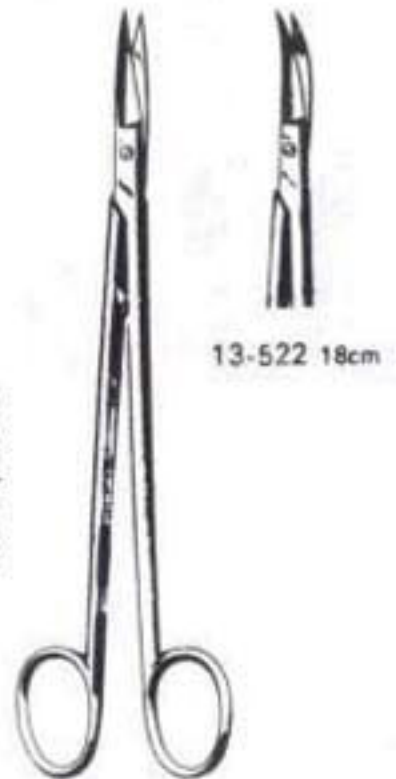

13-522 18cm

KELLY
13-520 18cm



GENERAL INSTRUMENTS

EYE SCISSORS



IRIS



13-530 11cm 13-532

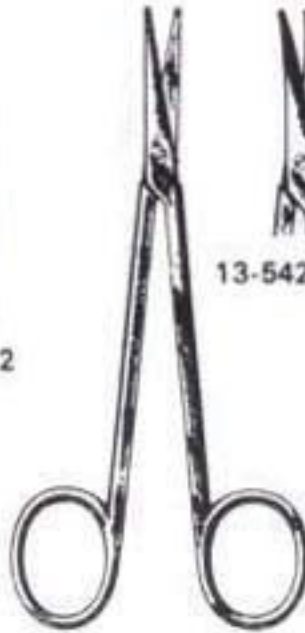

STRABISMUS
13-540 11.5cm



13-542 11.5cm



WESTCOTT
13-550 11.5cm 13-560



TENOTOMY SCISSORS



STEVENS



13-570 11cm 13-572



ENTEROTOMY
13-580 17cm
13-582 21cm

DENTAL SCISSORS



BEEBEE
13-590 10cm



13-592 10cm



BEEBEE
13-600 10 cm

13-602 10cm



GENERAL INSTRUMENTS DRESSING AND TISSUE FORCEPS



**ENGLISH
T.O.E.**
15-100 10 cm
15-102 12.5cm
15-104 15 cm
15-106 18 cm
15-108 20 cm



**ENGLISH
B/END**
15-110 12.5cm
15-112 15 cm
15-114 18 cm



THUMB
15-120 11.5cm
15-121 12.5cm
15-122 14 cm
15-123 16 cm
15-124 18 cm
15-125 20 cm
15-126 25 cm
15-127 30 cm



TREVES
15-130 12.5cm
15-132 15 cm
15-134 18 cm



**1-2
TISSUE**
15-140 11.5cm
15-141 12.5cm
15-142 14 cm
15-143 16 cm
15-144 18 cm
15-145 20 cm
15-146 25 cm



**2-3
TISSUE**
15-150 12.5cm
15-152 14 cm
15-154 16 cm
15-156 18 cm
15-158 20 cm



**3-4
TISSUE**
15-160 12.5cm
15-162 14 cm
15-164 16 cm



**4-5
TISSUE**
15-170
15-172
15-174



BROPHY
15-180 20cm



BROPHY
15-190 20cm



POTTS - SMITH
15-200 18 cm
15-202 21 cm
15-204 25 cm



15-210
15-212
15-214



GENERAL INSTRUMENTS DRESSING AND TISSUE FORCEPS



CUSHING
15-220 17.5cm



CUSHING
15-230 17.5cm



1:2
BROPHY
15-240 20cm



1:2
BROPHY
15-250 20 cm



1:2
POTTS-SMITH
15-260 18 cm
15-262 21 cm
15-264 25 cm



1:2
15-270
15-272
15-274



1:2
CUSHING
15-280 17.5cm



1:2
CUSHING
15-290 17.5cm



ADSON
15-300 12cm



McINDOE
15-310 15cm



SEMKEN
15-320 12.5cm
15-322 15 cm



1:2
ADSON
15-330 12cm



1:2
GILLIES
15-340 15cm



DRESSING & TISSUE FORCEPS



1:2
SEMKEN
15-350 12.5cm
15-352 15 cm



1:2
JEANS
15-360 14.5cm
15-362 17.5cm



2:3
RAMSAY
15-370 17.5cm



RUSSAIN
15-380 15cm
15-382 20cm
15-384 25cm



1:2
BONNEY
15-390 18cm



2:3
BONNEY
15-400

SPLINTER FORCEPS



1:2
LANE
15-410 12.5cm
15-412 15 cm
15-414 18 cm
15-416 20 cm



2:3
LANE
15-420 15cm
15-422 18cm



15-430 10.5cm
15-432 11.5cm
15-434 12.5cm



FEILCHENEELD
15-440 9 cm
15-442 11.5cm



HUNTER
15-450 10.5cm



15-460



SPLINTER FORCEPS



WALTER CARMALT
15-470 10.5cm 15-480



PEET
15-490 11.5cm



STIEGLITZ
STR CUR
15-500 14cm 15-502



ARTHUR
STR CUR
15-510 14cm 15-512



RALK
15-520 *5cm

HAEMOSTATIC FORCEPS



CARREL
17-100 8.5cm

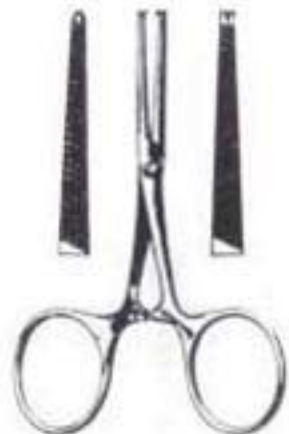

TERRIER
17-110 8.5cm



GENERAL INSTRUMENTS HAEMOSTATIC FORCEPS

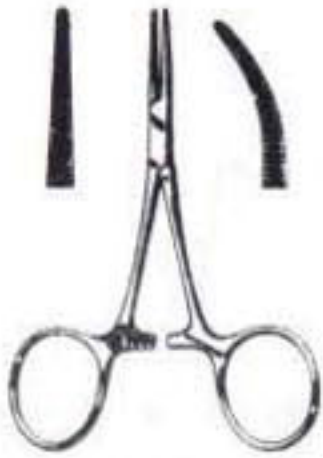

HARTMAN
STR 17-120 10cm CUR 17-122



**HALSTEAD
MOSQUITO**
17-130 12.5cm
17-132 12.5cm CUR



**HALSTEAD
MOSQUITO**
STR 17-140 12.5cm CUR 17-142



**1:2
HALSTEAD
MOSQUITO**
STR 17-150 12.5cm CUR 17-152

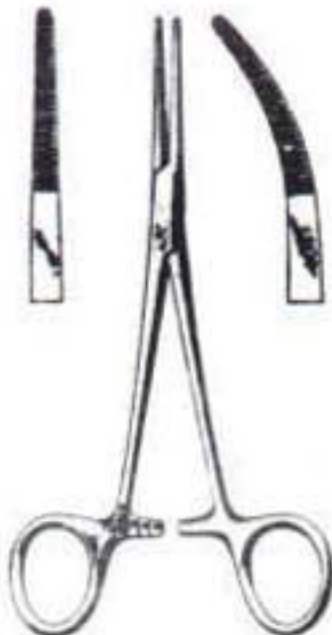

KELLY
STR 17-160 14cm CUR 17-162



CRILE
STR 17-170 14cm CUR 17-172

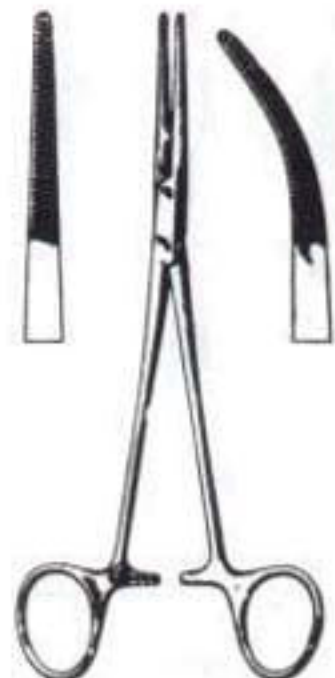

KELLY-RANKIN
STR 17-180 16cm CUR 17-182



GENERAL INSTRUMENTS DRESSING AND TISSUE FORCEPS



CUSHING
15-220 17.5cm



CUSHING
15-230 17.5cm



1:2
BROPHY
15-240 20cm



1:2
BROPHY
15-250 20 cm



1:2
POTTS-SMITH
15-260 18 cm
15-262 21 cm
15-264 25 cm



1:2
15-270
15-272
15-274



1:2
CUSHING
15-280 17.5cm



1:2
CUSHING
15-290 17.5cm



ADSON
15-300 12cm



McINDOE
15-310 15cm



SEMKEN
15-320 12.5cm
15-322 15 cm



1:2
ADSON
15-330 12cm



1:2
GILLIES
15-340 15cm



GENERAL INSTRUMENTS HAEMOSTATIC FORCEPS



KROENLEIN
17-270 14cm 17-272



SPENCERWELLS

| STR | | CUR |
|--------|--------|--------|
| 17-280 | 12.5cm | 17-290 |
| 17-282 | 15 cm | 17-292 |
| 17-284 | 18 cm | 17-294 |
| 17-286 | 20 cm | 17-296 |
| 17-288 | 23 cm | 17-298 |



SPENCERWELLS

| STR | | CUR |
|--------|--------|--------|
| 17-300 | 12.5cm | 17-310 |
| 17-302 | 15 cm | 17-312 |
| 17-304 | 18 cm | 17-314 |
| 17-306 | 20 cm | 17-316 |
| 17-308 | 23 cm | 17-318 |



KILNER
17-320 14cm



GREY-TURNER
17-330 15cm



DUNHILL
17-340 12.5cm



GENERAL INSTRUMENTS

HAEMOSTATIC FORCEPS



KOCHER

| STR | CUR |
|--------|---------------|
| 17-350 | 12.5cm 17-360 |
| 17-352 | 14 cm 17-362 |
| 17-354 | 16 cm 17-364 |
| 17-356 | 18 cm 17-366 |
| 17-358 | 20 cm 17-368 |



KOCHER

| STR | CUR |
|--------|---------------|
| 17-370 | 12.5cm 17-380 |
| 17-371 | 14 cm 17-381 |
| 17-372 | 15 cm 17-382 |
| 17-373 | 16 cm 17-383 |
| 17-374 | 18 cm 17-384 |
| 17-375 | 20 cm 17-385 |
| 17-376 | 23 cm 17-386 |
| 17-377 | 26 cm 17-387 |

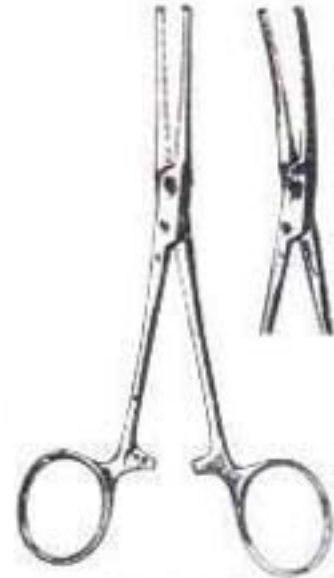

ROCHESTER OCHSNER

| STR | CUR |
|--------|-------------|
| 17-390 | 14cm 17-400 |
| 17-391 | 16cm 17-401 |
| 17-392 | 18cm 17-402 |
| 17-393 | 20cm 17-403 |
| 17-394 | 22cm 17-404 |
| 17-395 | 24cm 17-405 |
| 17-396 | 26cm 17-406 |



ROCHESTER CARMALT

| STR | CUR |
|--------|-------------|
| 17-410 | 16cm 17-420 |
| 17-412 | 20cm 17-422 |



CHAPUT

| | |
|--------|------|
| 17-430 | 13cm |
|--------|------|



LANE

| | |
|--------|--------|
| 17-440 | 12.5cm |
| 17-442 | 16 cm |
| 17-444 | 19 cm |



GENERAL INSTRUMENTS HAEMOSTATIC FORCEPS



COLLIN
17-450 16cm
17-452 16cm
17-454 16cm
17-456 16cm



17-452



17-454



17-456



HOEPFNER
17-460 16cm



COLLIN
17-470 14cm



WILLET-MARTEL
17-480 19cm



PRATT
17-490 15cm



PENNINGTON
17-500 15.5cm
17-502 20 cm



GENERAL INSTRUMENTS

HAEMOSTATIC FORCEPS



17-510

17-514

17-512

17-516

HALSTEAD MOSQUITO

| | STR | | CUR | |
|--------|----------|--------|-----|--|
| 17-510 | 18cm | 17-512 | | |
| 17-514 | 1:2 18cm | 17-516 | 1:2 | |
| 17-520 | 20cm | 17-522 | | |
| 17-524 | 1:2 20cm | 17-526 | 1:2 | |

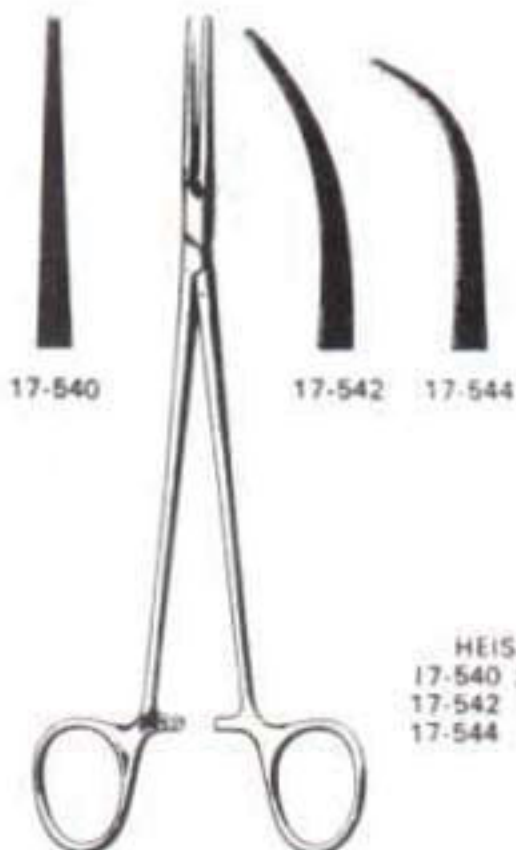

17-540

17-542

17-544

HEISS
17-540 20cm
17-542
17-544



BAINBRIDGE

| | STR | | CUR |
|--------|------|--------|-----|
| 17-550 | 15cm | 17-560 | |
| 17-552 | 18cm | 17-562 | |

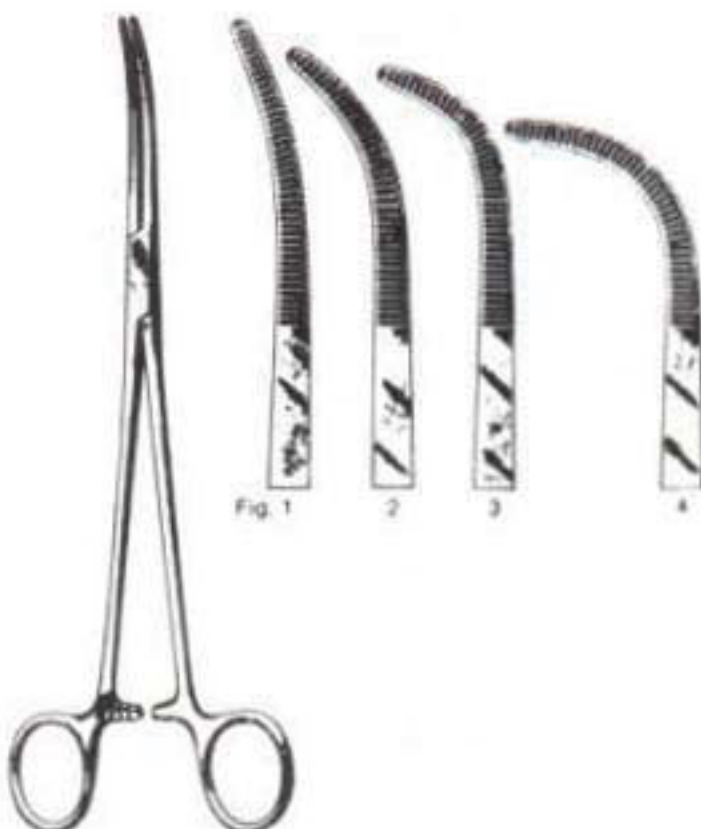

Fig. 1

2

3

4

RUMMEL

| | | |
|--------|--------|------|
| 17-570 | Fig. 1 | 23cm |
| 17-572 | Fig. 2 | 23cm |
| 17-574 | Fig. 3 | 23cm |
| 17-576 | Fig. 4 | 23cm |



GENERAL INSTRUMENTS HAEMOSTATIC AND GALL DUCT FORCEPS

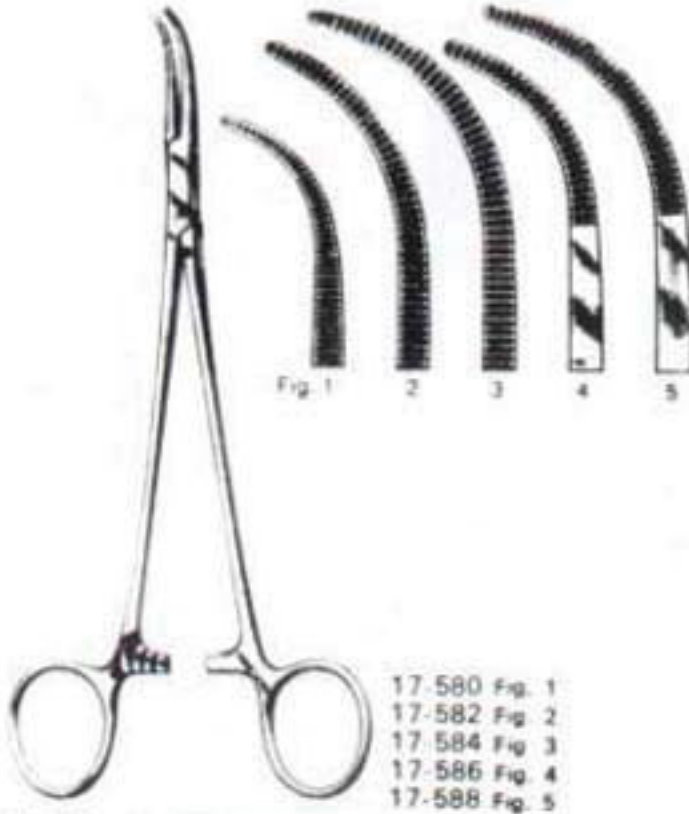

OVERHOLT - GEISSENDORFER
21cm

- 17-580 Fig. 1
- 17-582 Fig. 2
- 17-584 Fig. 3
- 17-586 Fig. 4
- 17-588 Fig. 5



MIXTER
17-590 15,5cm
17-592 19 cm



MIXTER
17-600 15,5cm
17-602 19 cm



MIXTER
17-610 Fig. 1 22cm
17-612 Fig. 2 25cm
17-614 Fig. 3 28cm



GENERAL INSTRUMENTS

GALL DUCT FORCEPS



BABY MIXTER
17-620 14cm



LAHEY
17-630 19cm



LOWER
17-640 18cm



FINOCHIETTO
17-650 24cm

KIDNEY PEDICAL FORCEPS



STILLE
17-660 23cm



MAYO
17-670 23cm



MAYO-GUYON
17-680 23cm



GUYON
17-690 23.5cm



GENERAL INSTRUMENTS

GALL DUCT FORCEPS

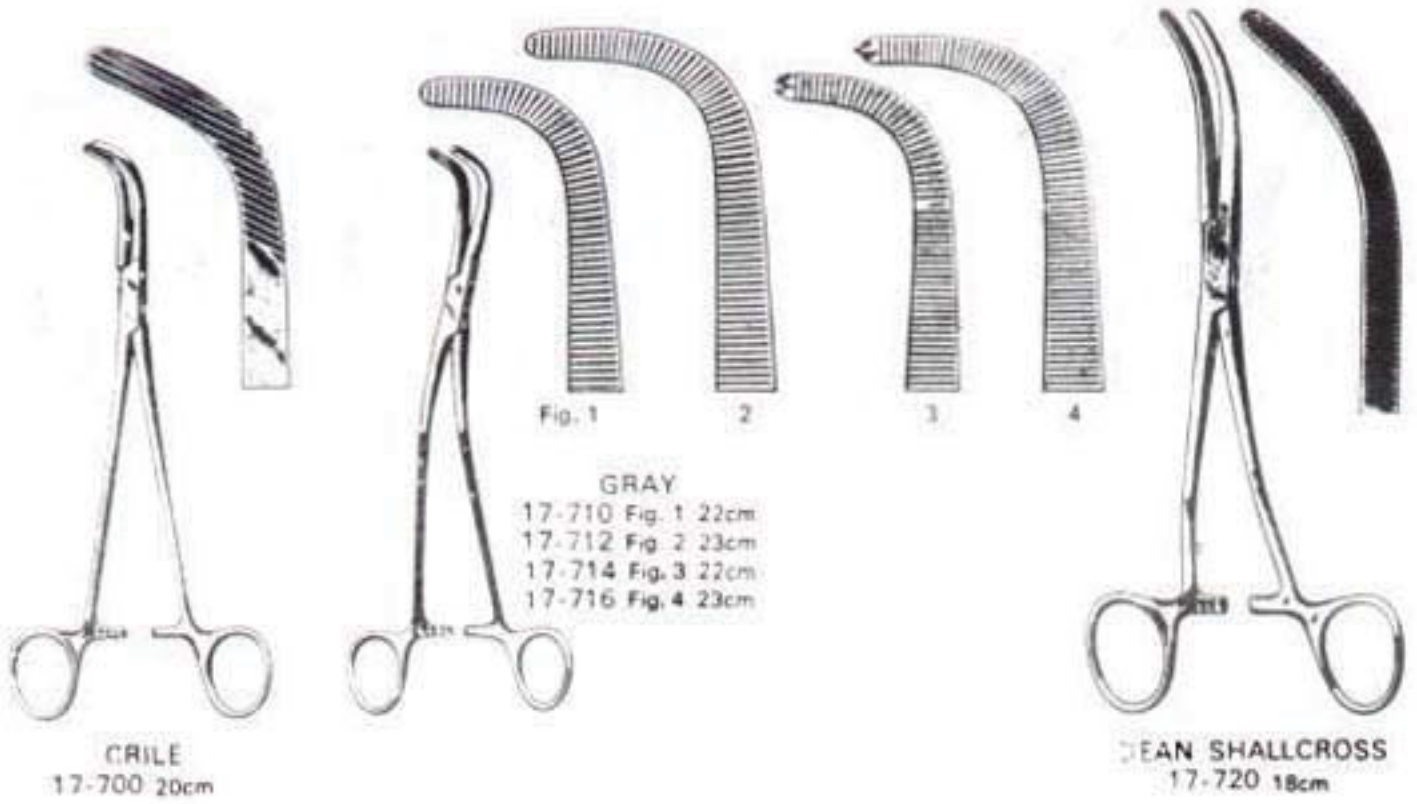

PERITONEAL FORCEPS





GENERAL INSTRUMENTS HYSTERECTOMY FORCEPS



MOYNIHAN
17-770 23cm
17-772 24cm



SPENCERWELLS
17-780 24cm
17-782 24cm
17-784 24cm
17-786 24cm



FAURE
17-790 25cm



WERTHEIM
17-800 25cm



WERTHEIM
17-810 23cm



WERTHEIM-CULLEN
17-820 21.5cm



GENERAL INSTRUMENTS

PERITONEAL FORCEPS



17-830

17-832

WERTHEIM
17-830 22cm
17-832 23cm



17-840

17-842

FAURE
17-840 20cm
17-842 20cm



17-850

17-852

MIKULICZ
17-850 20cm
17-852 20cm



MIKULICZ
17-860 20cm

BRONCHUS FORCEPS



ROBERTS
STR CUR
17-870 22cm 17-872



CRAFOORD
17-880 24cm

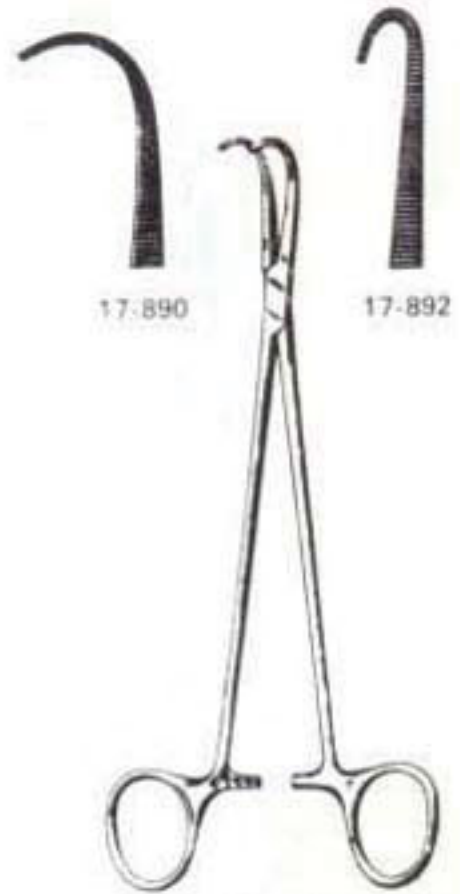

17-890

17-892

NEGUS
17-890 19cm
17-892 18cm



GENERAL INSTRUMENTS TOWEL CLAMPS



BACKHAUS
17-900 8cm
17-902 10cm
17-904 13cm



BACKHAUS
17-910 8cm
17-912 10cm
17-914 13cm



ROEDER
17-920 13cm
17-922 15cm



MAYO
17-930 14cm



MOYNIHAN
17-940 19cm



MOYNIHAN
17-950 18cm



DOYEN
17-960 18cm



SCHAEDEL
17-970 9cm



JONES
17-980 9cm



GENERAL INSTRUMENTS

SINUS AND DRESSING FORCEPS

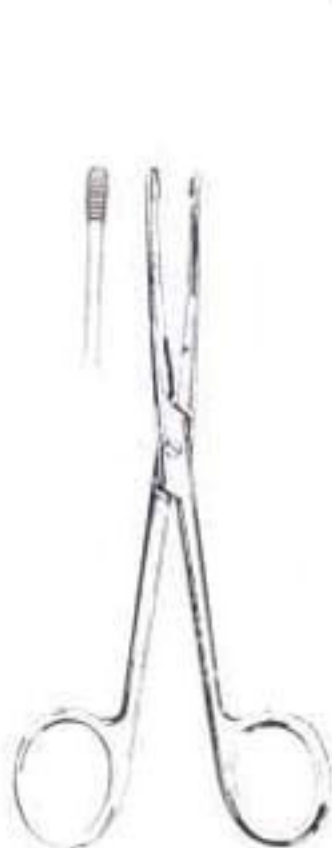

LISTER
 19-790 12.5cm
 19-792 15 cm
 19-794 18 cm
 19-796 20 cm



LISTER
 19-800 12.5cm
 19-802 15 cm
 19-804 18 cm
 19-806 20 cm



BRYANT
 19-810 12.5cm



BRYANT
 19-820 12.5cm



FRENCH
 STR 19-830 12.5cm
 CUR 19-832



GROSS
 STR 19-840 14cm
 CUR 19-850
 19-842 16cm 19-952



GROSS
 STR 19-860 18cm
 CUR 19-870
 19-862 20cm 19-872



GROSS
 STR 19-880 18cm
 CUR 19-890
 19-882 20cm 19-892



GENERAL INSTRUMENTS

DRESSING FORCEPS



GROSS
STR 19-900 20cm CUR 19-902



MAIER
STR 19-910 25cm CUR 19-912

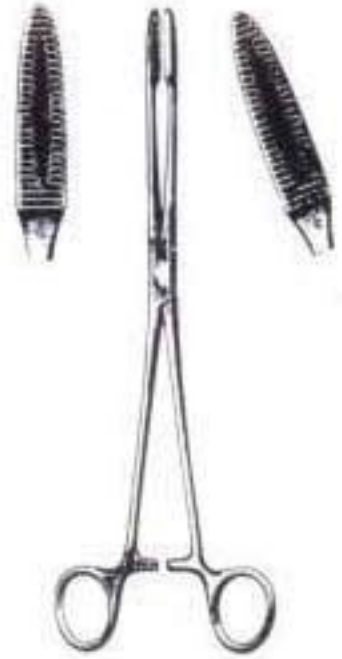

MAIER
STR 19-920 25cm CUR 19-922



SIMS-MAIER
STR 19-930 28cm CUR 19-932



COLLIN
19-940 25cm



CHERON
19-950 25cm S/Lock
19-952 25cm B/Lock



GENERAL INSTRUMENTS DRESSING AND SPONGE FORCEPS



19-960 26cm



BOZEMAN
19-962 26cm



BOZEMAN-DOUGLAS
19-970 26cm



EMMET
19-980 23cm



BALLENGER 18cm
STR CUR
19-990 SMOOTH 19-992
19-1000 SERRATED 19-1002
FOERSTER 25cm
19-1010 SMOOTH 19-1012
19-1020 SERRATED 19-1022



RAMPLEY
19-1030 18cm
19-1032 25cm



RAMPLEY
19-1040 18cm
19-1042 25cm



GENERAL INSTRUMENTS RETRACTORS



FARABEU
21-100 12cm
21-102 15cm



PARKER
21-110 13.5cm



U. S. ARMY
21-120 21cm



ROUX
21-130 Set
21-132 14cm
21-134 15cm
21-136 16cm

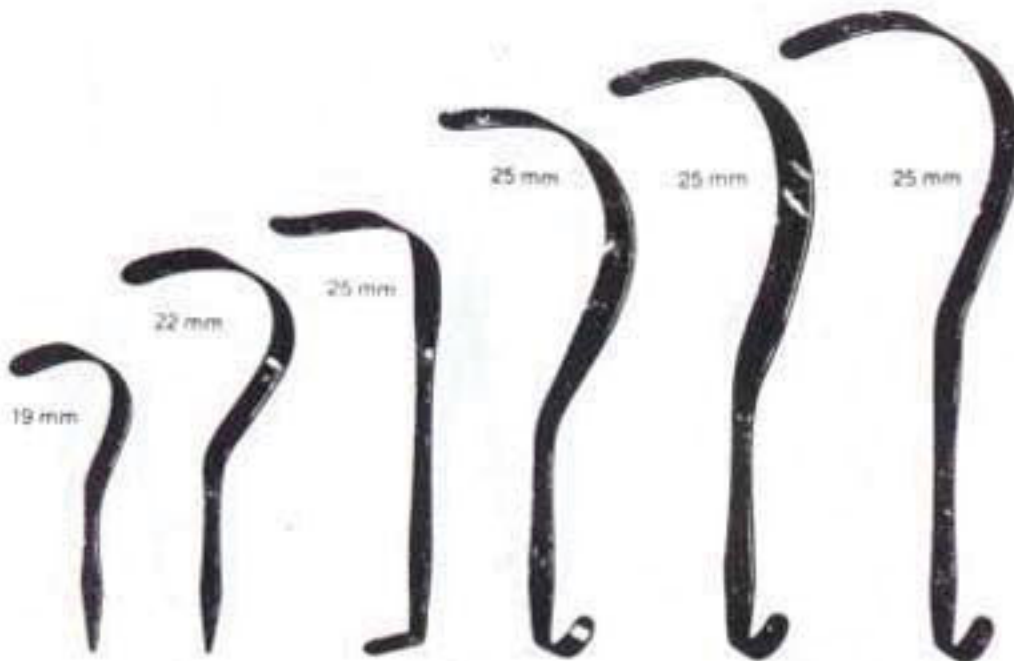

DEAVER
21-140 18cm 21-141 21.5cm 21-142 23cm 21-143 30cm 21-144 33cm 21-145 36cm



GENERAL INSTRUMENTS RETRACTORS



DEAVER
21-146 30cm 21-147 30cm 21-148 30cm HARRINGTON
21-149 32cm

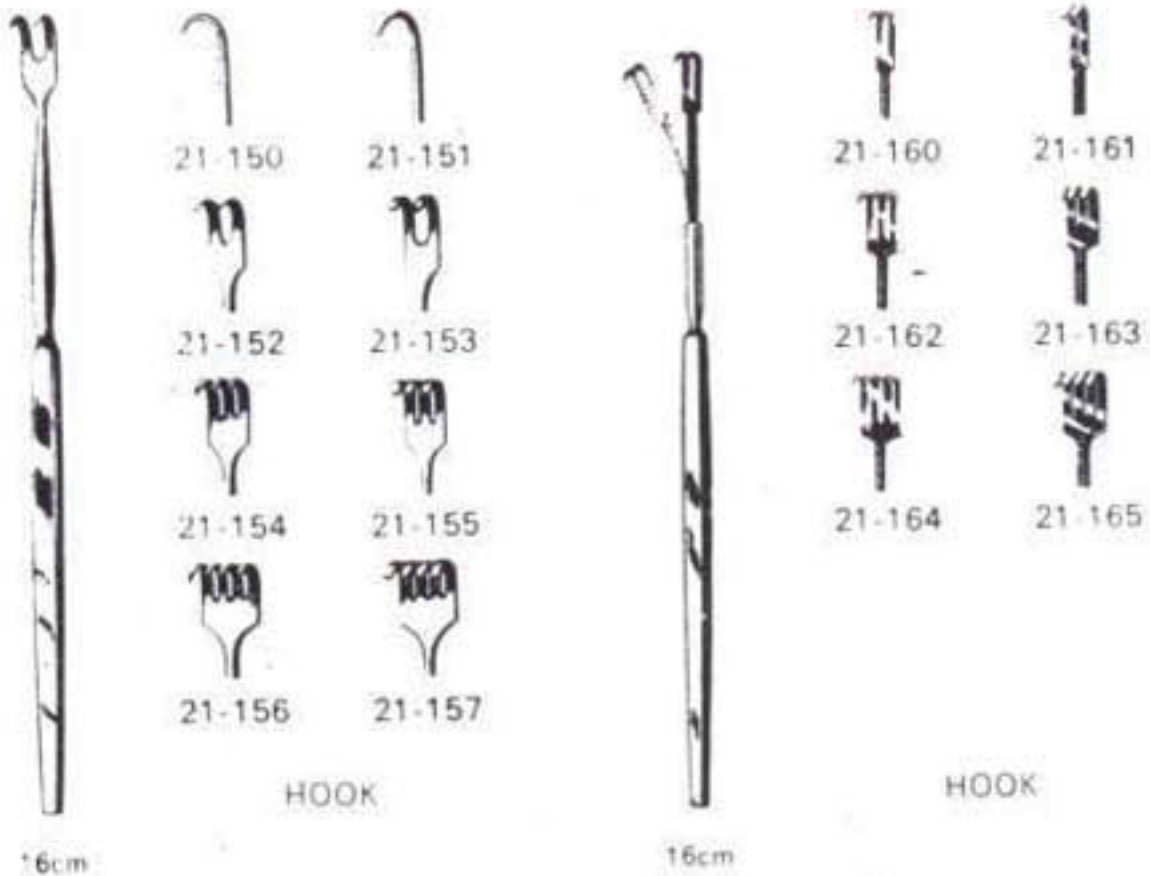

HOOK

HOOK



GENERAL INSTRUMENTS

RETRACTORS



KOCHER
22cm



21-170



21-171



21-172



21-173



21-174



21-175



21-176



21-177



21-178



21-179



VOLKMAN
21.5cm



21-180



21-181



21-182



21-183



21-184



21-185



21-186



21-187



21-188



21-189



GENERAL INSTRUMENTS RETRACTORS





GENERAL INSTRUMENTS

RETRACTORS



28 - 20 mm

21-280

36 - 23 mm

21-282

44 - 38 mm

21-284

RICHARDSON
24cm

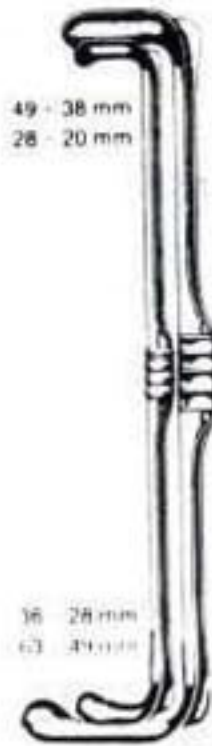

49 - 38 mm
28 - 20 mm

36 - 28 mm
63 - 41 mm

RICHARDSON EASTMAN
21-290 26cm
21-292 28cm



40 - 10 mm
40 - 15 mm
40 - 20 mm

KOCHER
21-300 22cm
Fig. 1 to 3



41 - 40 mm

FRITSCH
21-310 24cm

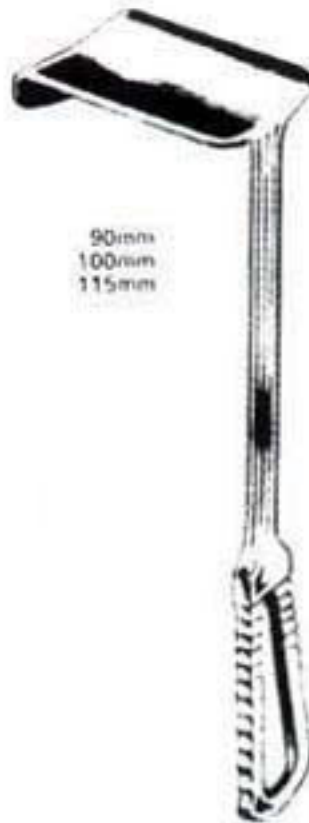

90mm
100mm
115mm

MORRIS
21-320 90mm
21-322 100mm
21-324 115mm



57x64mm 48mm

57x50mm 48mm

MORRIS
21-330



GENERAL INSTRUMENTS

RETRACTORS



90x55mm
75x25mm
50x16mm

MEYERDING
21-340 24cm
21-342 22cm
21-344 20cm

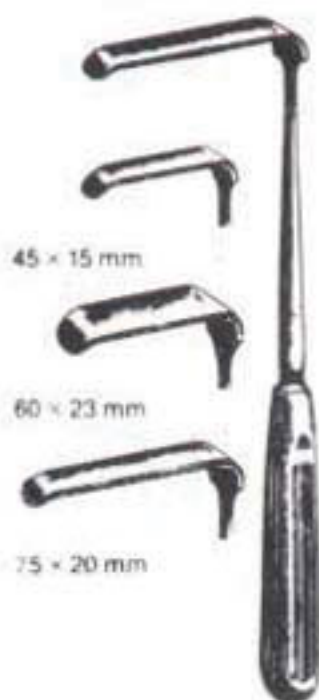

45 x 15 mm

60 x 23 mm

75 x 20 mm

SAUERBUCH
21-350 22.5cm
Fig. 1 to 3

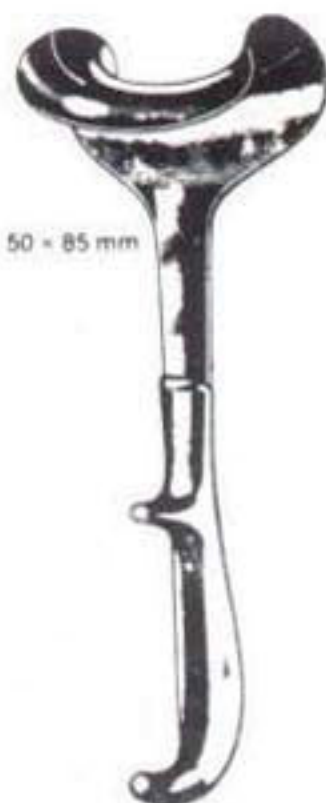

50 x 85 mm

DOYEN
21-360 25cm



190 x 38 mm
190 x 57 mm

KELLY
21-370 27cm
Fig. 1 to 2



85 x 35 mm

MIKULICZ
21-380 26cm

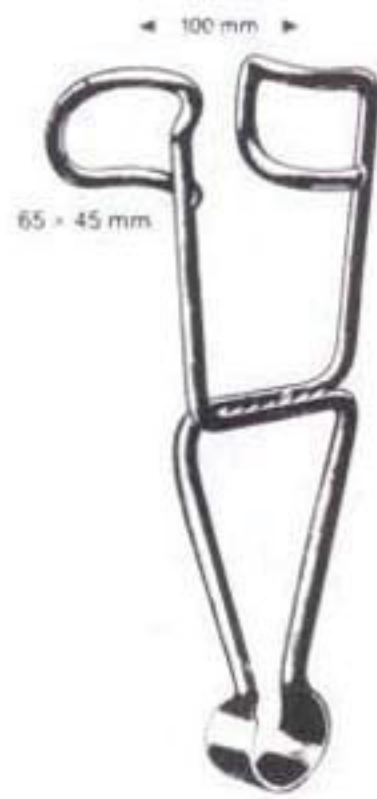

100 mm
65 x 45 mm

DARTIGUES
21-390



GENERAL INSTRUMENTS
RETRACTORS



WEITLANER
21-400 10.5cm SHARP
21-402 10.5cm BLUNT

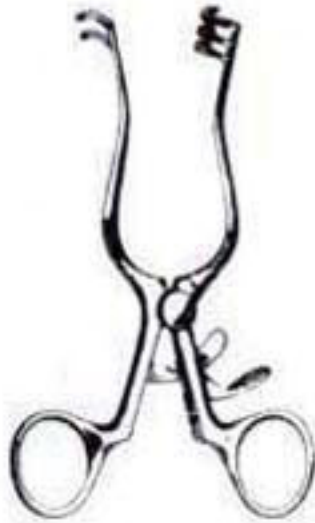

WEITLANER
21-410 10.5cm SHARP
21-412 10.5cm BLUNT

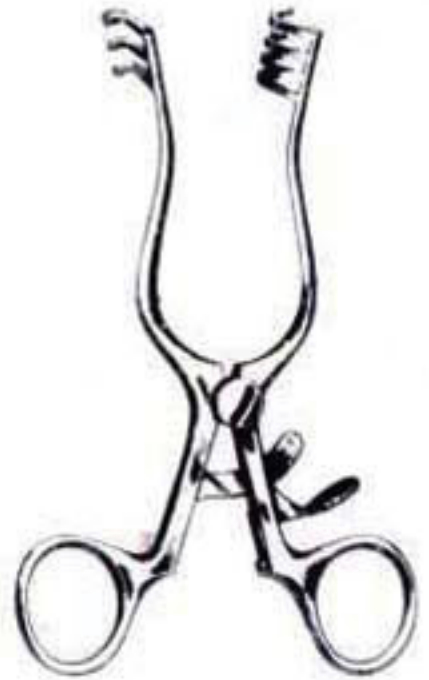

WEITLANER
21-420 13 cm SHARP
21-422 16.5cm SHARP
21-424 13 cm BLUNT
21-426 16.5cm BLUNT

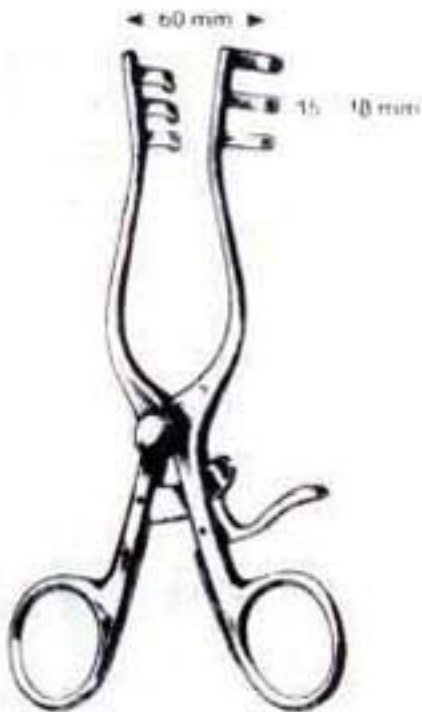

MILLIGAN
21-430 13cm



JANSEN
21-440 10cm

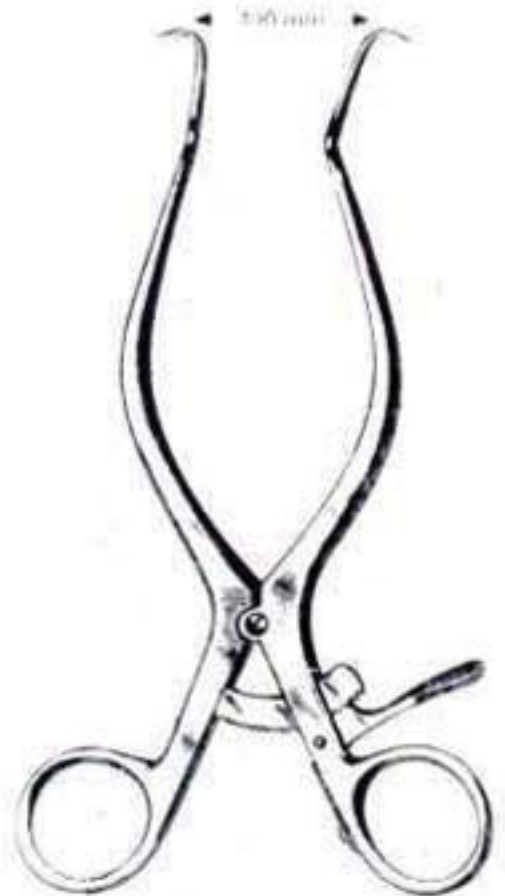

GELPI
21-450 18cm



GENERAL INSTRUMENTS RETRACTORS



MAYO-ADAMS
21-460
21-462 W/CENTRE BLADE



COLLIN
21-470
21-472 W/CENTRE BLADE

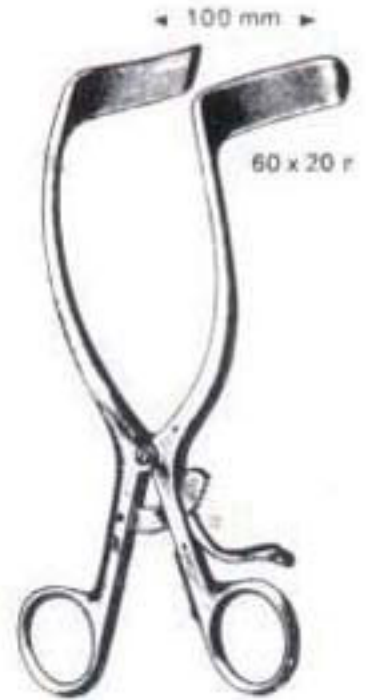

RIGBY
21-480 18cm

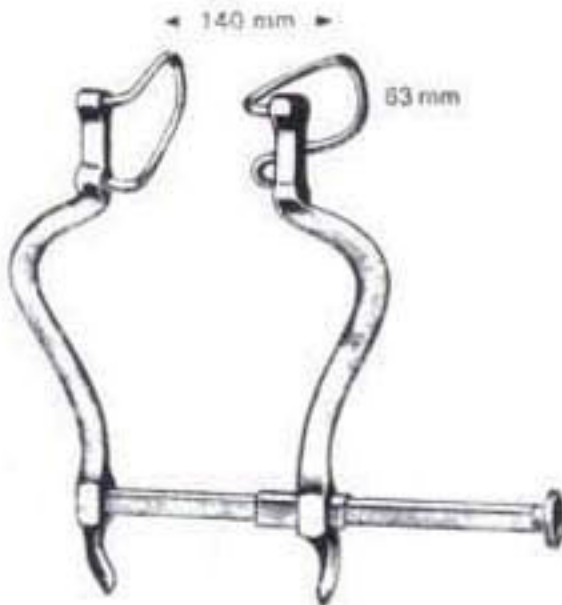

GOSSET
21-490

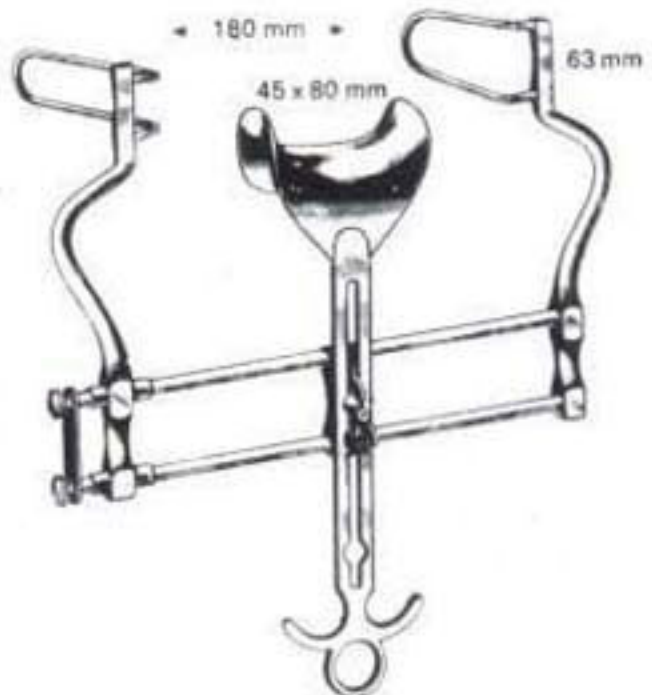

BALFOUR
21-500



GENERAL INSTRUMENTS

PROBES

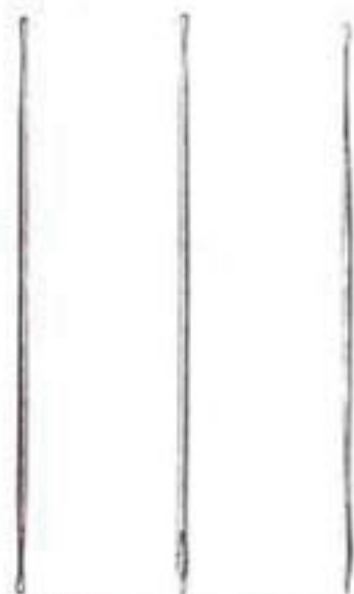

| | | | | |
|--------|--------|--------|--------|--------|
| 23-100 | 11.5cm | 23-110 | 23-120 | 12.5cm |
| 23-101 | 12.5cm | 23-111 | 23-122 | 14 cm |
| 23-102 | 14 cm | 23-112 | 23-124 | 16 cm |
| 23-103 | 16 cm | 23-113 | | |
| 23-104 | 18 cm | 23-114 | | |
| 23-105 | 20 cm | 23-115 | | |
| 23-106 | 25 cm | 23-116 | | |

DIRECTOR

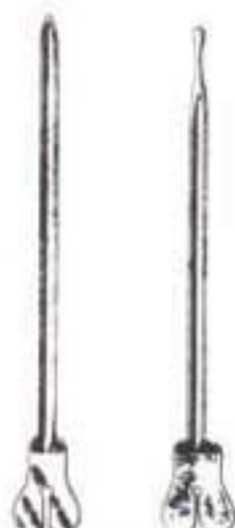

| | | |
|--------|--------|--------|
| 23-130 | 12.5cm | 23-140 |
| 23-132 | 14 cm | 23-142 |
| 23-134 | 16 cm | 23-144 |

SAFETY PIN



MAYO
23-150 14cm

SPATULA



PLASTER
23-160 13cm
23-162 16cm

NEEDLES

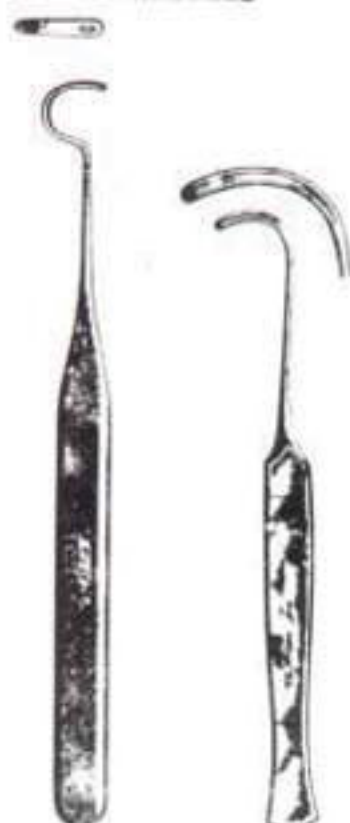

23-170 13cm

SYME
23-180

DISSECTORS



McDONALD
23-190 19cm

CHEYNE
23-200 12.5cm
23-202 17.5cm

APPLICATORS



FARHELL
23-210 12cm
23-212 14cm
23-214 16cm
23-216 18cm
23-220
23-222
23-224
23-226

JOBSON HORNE
23-230 12.5cm
23-232 18cm



SUTURE NEEDLE HOLDERS



DERRF
25-100 12cm



COLLIER
25-110 12.5cm



WEBSTER
25-120 13cm



MAYO HEGAR
25-130 14cm
25-131 16cm
25-132 18cm
25-133 20cm
25-134 24cm
25-135 26cm



CRILEWOOD
25-140 15cm



CRILEMURRAY
25-150 15cm



WRIGHT
25-160 13cm



BRUCE - CLARKE
25-170 12.5cm



SUTURE NEEDLE HOLDERS



KILNER
25-180 13.5cm



THOMSON-WALKER
25-190 18cm



BOZEMAN
25-200 20cm



METZENBAUM
25-210 18cm



FINOCHIETTO
25-220 22cm



WANGENSTEEN
25-230 27cm



MASSON
25-240 27cm



SAROT
25-250 18cm
25-252 26cm



SUTURE NEEDLE HOLDERS



OLSEN
25-260 14 cm
25-262 16.5cm
25-264 19 cm



GILLIS
25-270 16cm



MATHIEU
25-280 11cm
25-282 14cm
25-284 17cm



MATHIEU
25-290 14cm
25-292 17cm
25-294 20cm
25-296 24cm



25-300 14cm
25-302 17cm
25-304 20cm
25-306 24cm



LANGENBECK
25-310 16cm
25-312 20cm



CRILE
25-320 15cm



SUTURE NEEDLE HOLDERS



MACPHAIL
25-330 14cm
25-332 16cm
25-334 18cm
35-336 20cm



HALSTEAD
25-340 16.5cm
25-342 21 cm
25-344 24 cm



ROCHESTER-MAYO
25-350 18cm
25-352 20cm
25-354 22cm



STEVENS
25-360 13cm



KALT-ARRUGA
25-370 14cm



KALT
25-380 14cm



CASTROVIEJO
25-390 14cm

NEEDLES



DESCHAMPS
25-400 21cm L
25-402 21cm R



DESCHAMPS
25-410 21cm L
25-412 21cm R



**SUTURE
NEEDLES**



REVERDIN
19cm



Fig. 1
25-420



2
25-422



3
25-424



4
25-426



25-442



25-444



25-446



REVERDIN
19cm



Fig. 1
25-430



2
25-432



3
25-434



4
25-436



YOUNG BOOMPANG
25-440 25cm



SUTURE
SUTURE FORCEPS



MICHEL
25-450 12cm



MICHEL
25-460 12cm



WACHENFELDT
25-470 12.5cm



WACHENFELDT
25-480 12.5cm



HEGENBARTH
25-490 12.5

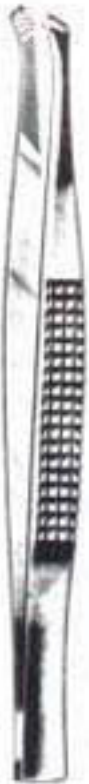

CHILD
25-500 18cm



CHILD
25-510 18cm

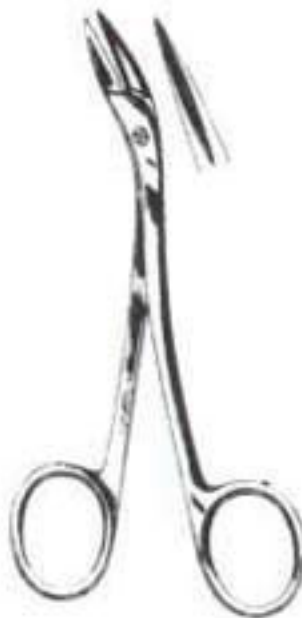

RICHTER-HEATH
25-520 14cm



MICHEL
25-530 13cm



MICHEL
25-540 12cm



PLASTER

SCISSORS



LISTER
27-100 9cm
27-102 11cm
27-104 14cm
27-106 18cm
27-108 20cm



KNOWLES
27-120 14cm



ESMARCH
27-130 20cm



SMITH
27-140 16cm
27-142 18cm
27-144 20cm
27-146 23cm

SHEARS



SEUTIN
27-150 23cm



WIRE & CLOTHING
27-160 20cm



BRUNS
27-170 24cm



BRUNS
27-180 24cm



PLASTER

SHEAR



STILLE
27-190 23cm
27-192 26cm
27-194 37cm

SAW



ENGEL
27-200

KNIFE



REINER
27-210 18cm

SPREADER

RING CUTTER



FINGER
27-220 16cm

CAST BREAKER



WOLFF
27-230 19cm
27-232 23cm
27-234 26cm



HENNING
27-240 28cm



BEESON
27-250 30cm



BONE SURGERY

BONE SAWS



CHARRIERE
29-100 27 cm
29-102 30 cm
29-104 33 cm



SATTERLEE
29-110 31 cm



POST MORTEN
29-120 20 cm Blade



CHARRIERE
29-130 35 cm

BONE CHISELS AND GOUGES



OSTEOTOMES
13.5 cm
29-140 8 mm
29-142 10 mm
29-144 12 cm
29-146 14 cm
29-148 16 cm



CHISELS
13.5 cm
29-150 8 mm
29-152 10 mm
29-154 12 cm
29-156 14 cm
29-158 16 cm



GOUGES
13.5 cm
29-160
29-162
29-164
29-166
29-168



STILLE
20 cm
29-170 10 mm
29-172 15 mm
29-174 20 mm
29-176 25 mm



STILLE
20 cm
29-180 10 mm
29-182 15 mm
29-184 20 mm
29-186 25 mm



STILLE
20 cm
29-190
29-192
29-194
29-196



BONE MALLETS



WILLIGER
29-200 24 cm



DOYEN
29-210 21 cm



COLLIN
29-220 20 cm

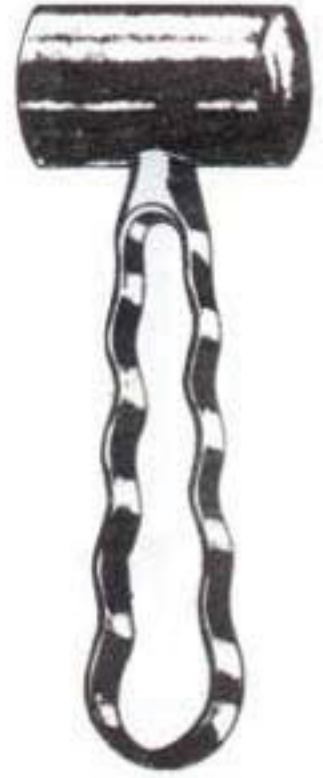

HEATH
29-230 18 cm

BONE SPOONS



VOLKMAN
29-240
0000 To 6

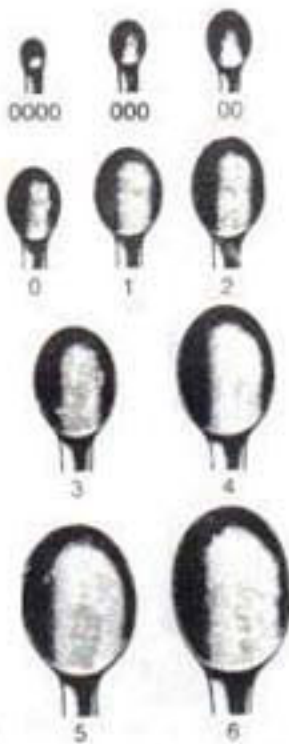

BRUNS
29-250
0000 To 6



VOLKMAN **VOLKMAN**
29-260 13 cm 29-270
29-262 16.5 cm 29-272
29-264 20 cm 29-274





BONE SURGERY

RASPATORIES



FARABEUF
29-280 15 cm 29-290



DOYEN
17 cm
29-300L ADULT 29-302 R
29-310L CHILD 29-312 R

ELEVATORS

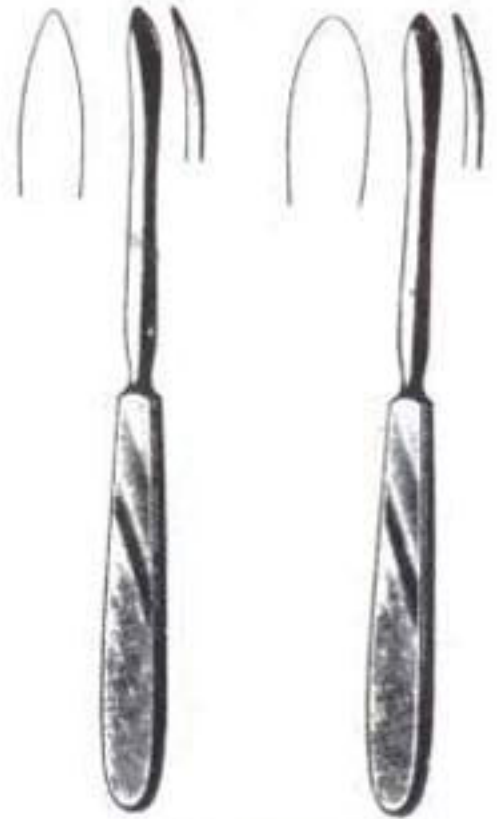

LANGENBECK
29-320 20 cm 29-330

ELEVATORS



WILLIGER
29-340 17 cm 29-350 16 cm

RASPATORIES



SEMB
29-360 29-361 29-362 29-363 29-364 29-365 29-366



BONE SURGERY

LEVERS



LANGE-HOHMANN
29-370 27 cm 29-380
29-372 29 cm 29-382

LEVERS AND FORCEPS



29-390



SEQUESTRUM
29-390 20 cm
29-392 20 cm



29-392



VAN BUREN
29-400 23 cm

BONE HOLDING FORCEPS



FERGUSSON
29-405 21 cm



LAGENBECK
29-410 21 cm



SEMB
29-420 19 cm



FARABEUF
29-430 23 cm
29-432 26 cm



FARABEUF-LAMBOTTE
22-440 26 cm



BONE SURGERY BONE HOLDING FORCEPS



LANE
29-450 31.5 cm
29-452 39 cm



LANE
29-460 33 cm
29-462 45 cm



KERN
29-470 17 cm
29-472 21 cm



KERN
29-480 17 cm
29-482 21 cm



LAMBOTTE
29-490 19 cm
29-492 23 cm
29-494 28 cm



LAMBOTTE
29-500 22 cm
29-502 26 cm
29-504 33 cm



BONE SURGERY

BONE RONGER

RETRACTOR



PERCY
29-510

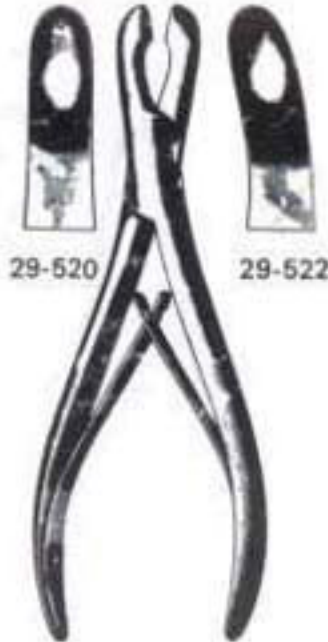

LUER
29-520 17 cm
29-522 17 cm



LEMPERT
29-530 19 cm



STILLE-LUER
29-540 22 cm



LEKSELL-STILLE
29-550 24 cm



RUSKIN
29-560 18 cm



BONE SURGERY

BONE RONGEUR



HARTMAN
29-570. 18.5cm



29-580

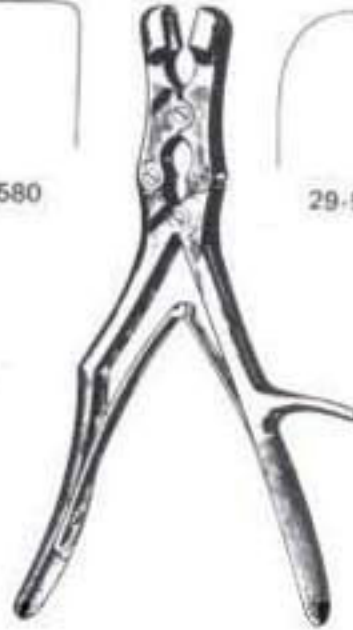

SAUERBRUCH
29-580 30cm
29-582 30cm



29-582



LISTON-KEY
29-590 27cm

BONE CUTTING FORCEPS



29-600



LISTON
STR CUR
29-600 14cm 29-610
29-602 17cm 29-612
29-604 19cm 29-614
29-606 22cm 29-616



29-610



RUSKIN-LISTON
29-620 18cm
29-622 18cm



29-622

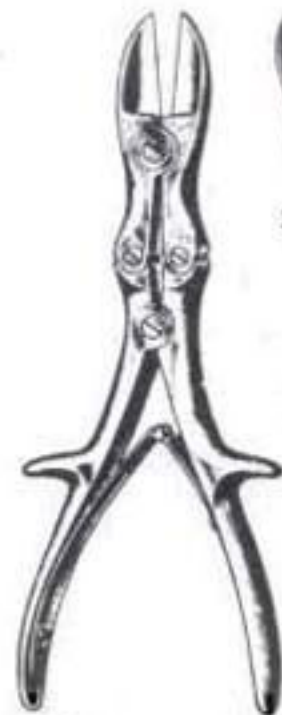

STILLE-LISTON
29-630 27cm
29-632 27cm



29-632



LUNG SURGERY

RIB SHEARS



31-100 20cm
31-102 23cm



COLLIN
31-120 19cm

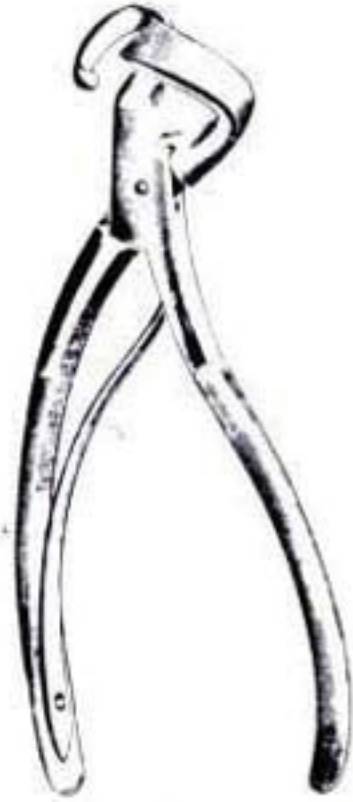

DOYEN
31-130 19cm

RIB SHEARS



BRUNNER
31-140 28cm

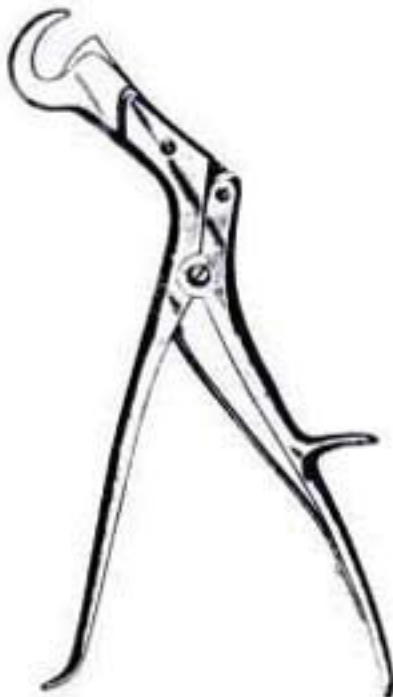

GIERTZ-STILLE
31-150 36cm

SPREADER

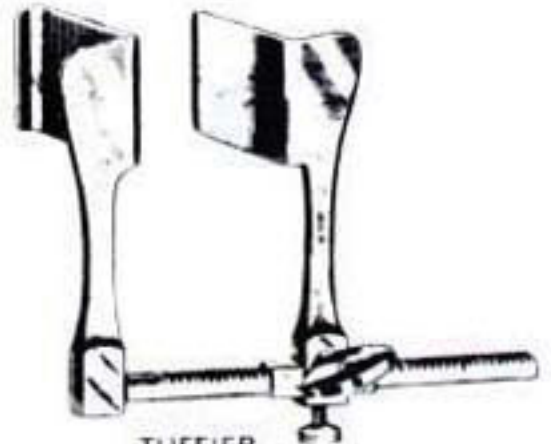

TUFFIER
31-160



CARDIOVASCULAR

BRONCHUS

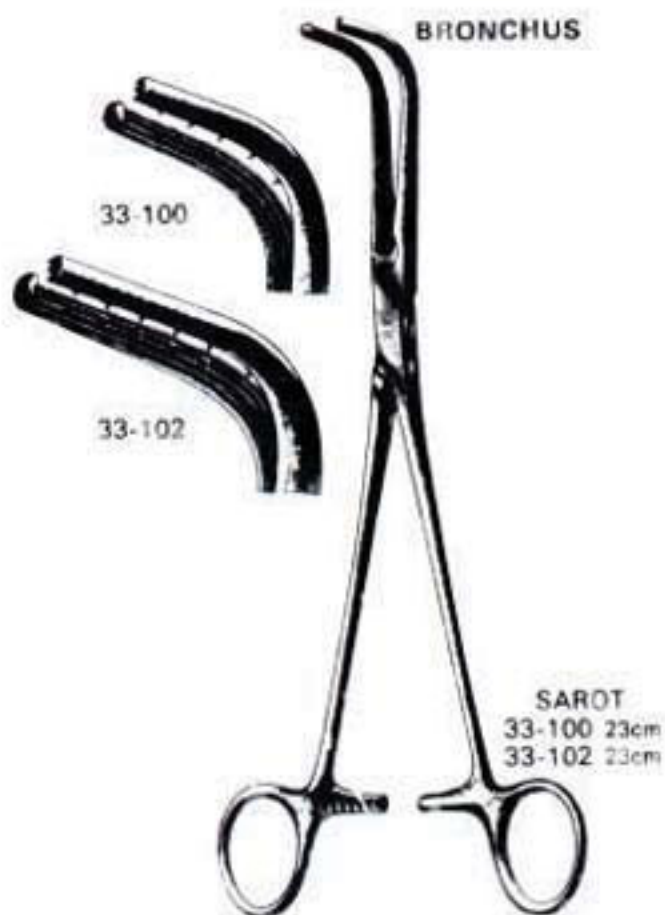

ANASTOMOSIS



ANASTOMOSIS

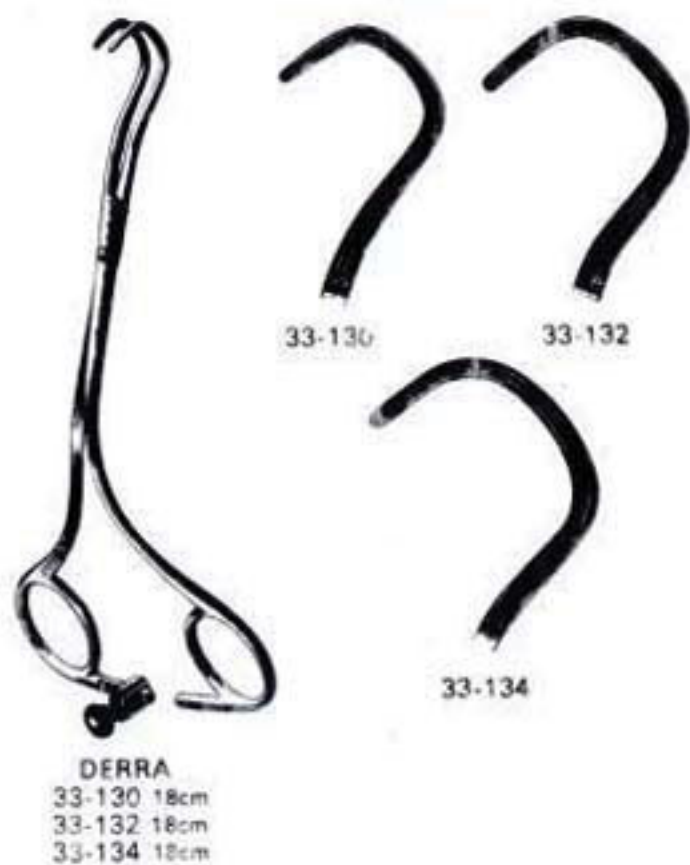

BRONCHUS

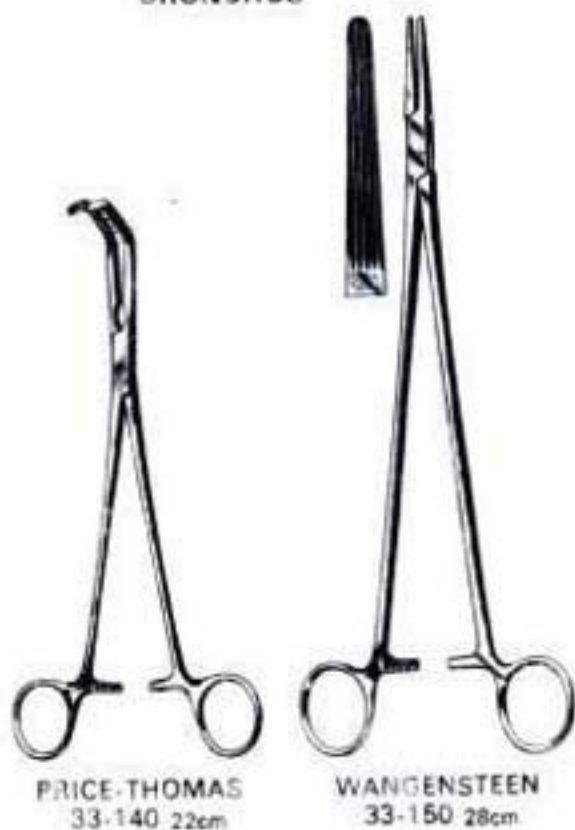



CARDIOVASCULAR LUNG GRASPING



LOVELACE
33-160 20cm



LOVELACE
33-170 20cm



HARRINGTON-ROCHESTER
33-180 30cm



DAVIDSON
33-190 23cm

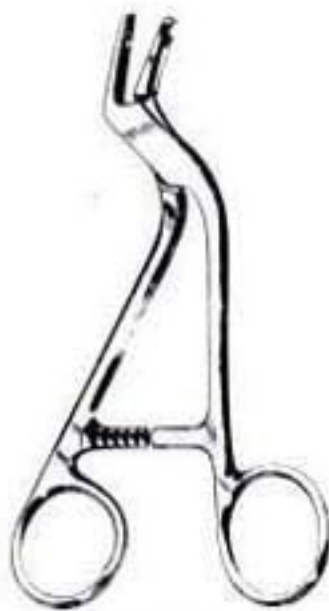

ADSON
33-200 15cm



BLALOCK
33-210 15cm
33-212 20cm
33-214 20cm



33-210



33-212



33-214



NEUROSURGERY

BRAIN CLAMPS SUCTION CANNULA

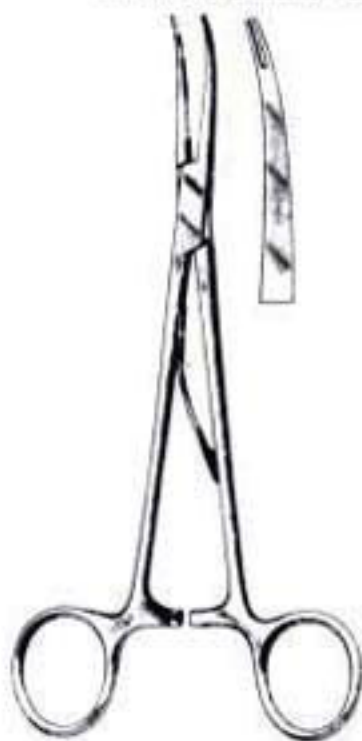

McKENZIE
35-100 15cm
35-102 19cm



FRAZIER
17cm
35-110 6 ch.G.
35-112 8 ch.G.
35-114 10 ch.G.
35-116 12 ch.G.



FRAZIER
35-120 13cm
35-122 17cm

NERVE HOOK



GRAHAM
35-130 16.5cm



SACHS
35-140 16.5cm

LAMINECTOMY RONGEURS



SPURLING-LOVE
35-150 28cm
35-152 28cm



OLDBERG
35-160 25cm



COLCLOUGH
35-170 27cm UP CUTTING
35-172 27cm DOWN CUTTING



35-150



35-152



OPHTHALMOLOGY EYE SPECULA



BOWMAN
37-100 7cm

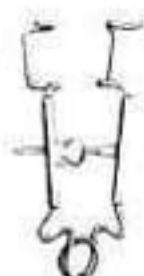

CRITCHETT
37-120 6cm



SMITH
37-130 5cm



CLARKE
37-140 8cm



GRAEFE
37-150 6cm
37-152 9cm

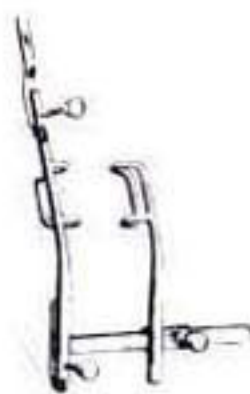

ARRUGA
37-160 7cm L
37-162 7cm R



MELLINGER
37-170 7cm



MUELLER
37-180 7cm



12mm

37-190



14mm

37-192



16mm

37-194



18mm

37-196

DESMARRES
37-190 12mm
37-192 14mm
37-194 16mm
37-196 18mm



OPHTHALMOLOGY

SCALPELS

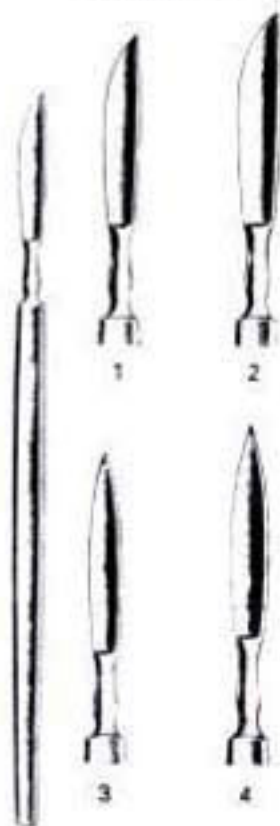

37-200 Fig 1
37-202 Fig 2
37-204 Fig 3
37-206 Fig 4



BEER
37-220 Fig 1
37-222 Fig 2

KNIVES



CATARACT
37-210 Fig 1
37-211 Fig 2
37-212 Fig 3
37-213 Fig 4
37-214 Fig 5
37-215 Fig 6



37-230 37-232 JAEGER 37-234 37-236



37-240 37-242 JAEGER 37-244 37-246



OPHTHALMOLOGY

KNIVES

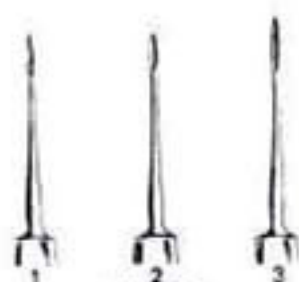

KNAPP
37-250 Fig 1
37-252 Fig 2
37-254 Fig 3

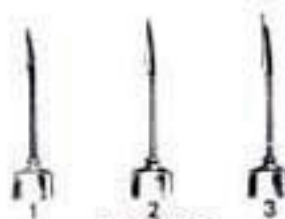

ZIEGLER
37-260 Fig 1
37-262 Fig 2
37-264 Fig 3

NEEDLES



CATARACT **FOREIGN BODY**
37-270 37-272 37-280 37-282

CYSTOTOMES

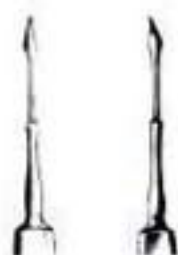

BOWMANN
37-290 37-292



37-300

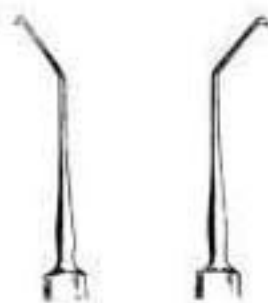

GRAEFE
37-302 37-304



GRAEFE
37-310 37-312



GUTHRIE
37-320 37-322



SCOOPS



WEBER
37-330 37-332

SNELLEN
37-340

SPOONS



DAVIEL
37-350 37-352

RETRACTORS



ROLLET
37-360

KNAPP
37-370



OPHTHALMOLOGY

HOOKS



37-380

GRAEFE
37-382

37-384

SCOOP



WELLS
37-390

SPATULAS

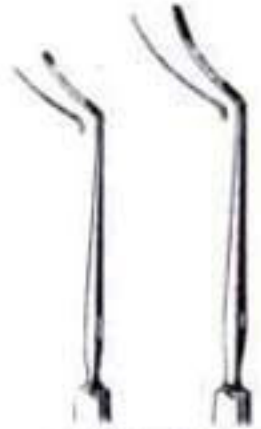

CASTROVIJO
37-400 37-402

CURETTES



WECKER
37-410 37-412



37-420

37-422

MEYHOEFER
37-424

37-426

37-428

CHISEL



ROLLET
37-430

FOREIGN BODY



WALTON
37-440

DIX
37-450



JAEGER
37-460



CASTROVIJO
37-470



OPHTHALMOLOGY

DILATORS

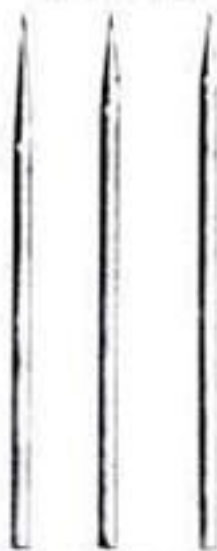

WILDER
37-480 Fig 1
37-482 Fig 2
37-484 Fig 3

PROBES

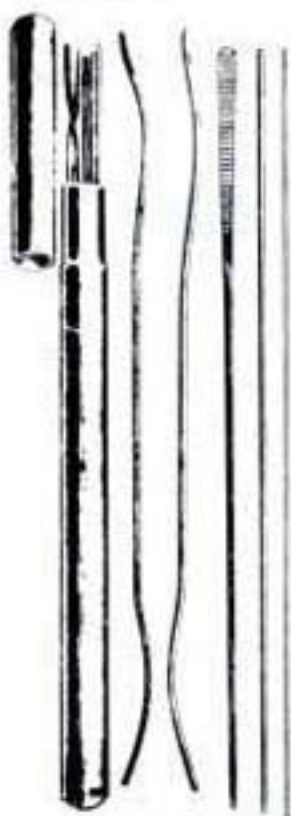

BOWMAN
37-490 SET

DISSECTOR



AXENFELD
37-500

SPATULAS

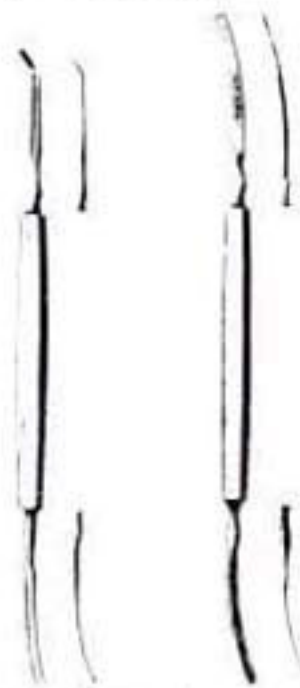

WHEELER
37-510

SMITH-FISHER
37-520



37-540



MEYHOEFER
37-550



37-560



37-570



37-580



37-590



37-600



OPHTHALMOLOGY IRIS FORCEPS



37-610



37-611



37-612



1.2
37-613



1.2
37-614



1.2
37-615

GRAEFE

| | | |
|----------|------|--------|
| SERRATED | | 1.2 |
| 37-610 | 10cm | 37-613 |
| 37-611 | 10cm | 37-614 |
| 37-612 | 10cm | 37-615 |



GRAEFE
STR
37-620 7cm



CUR
37-622



1.2
GRAEFE
STR
37-630 7cm



1.2
CUR
37-632



BISHOP-HARMAN
SERRATED
37-640 8.5cm



1.2
37-642



1.2
HESS
37-670 7cm



1.2
37-680



OPHTHALMOLOGY

IRIS FORCEPS

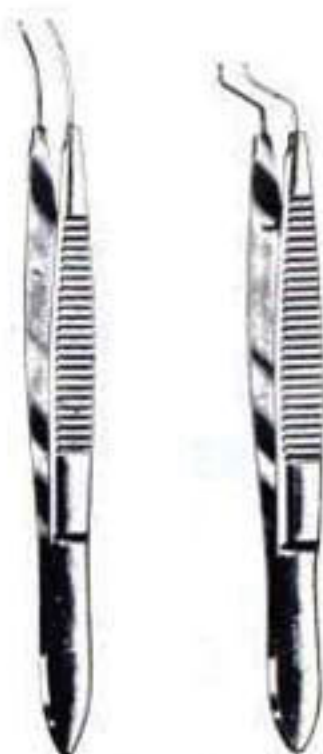

1:2 HESS 37-690 9cm 1:2 37-710



1:2 FISCHER 37-710 7cm 1:2 FISCHER 37-720

CAPSULAR FORCEPS

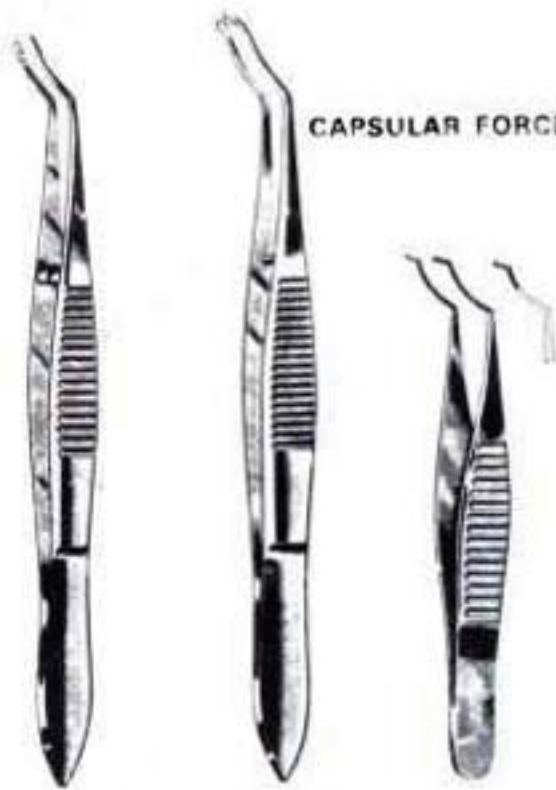

ARRUGA 37-730 9.5cm ELSCHING 37-740 10cm HESS 37-750 6.5cm

FIXATION FORCEPS

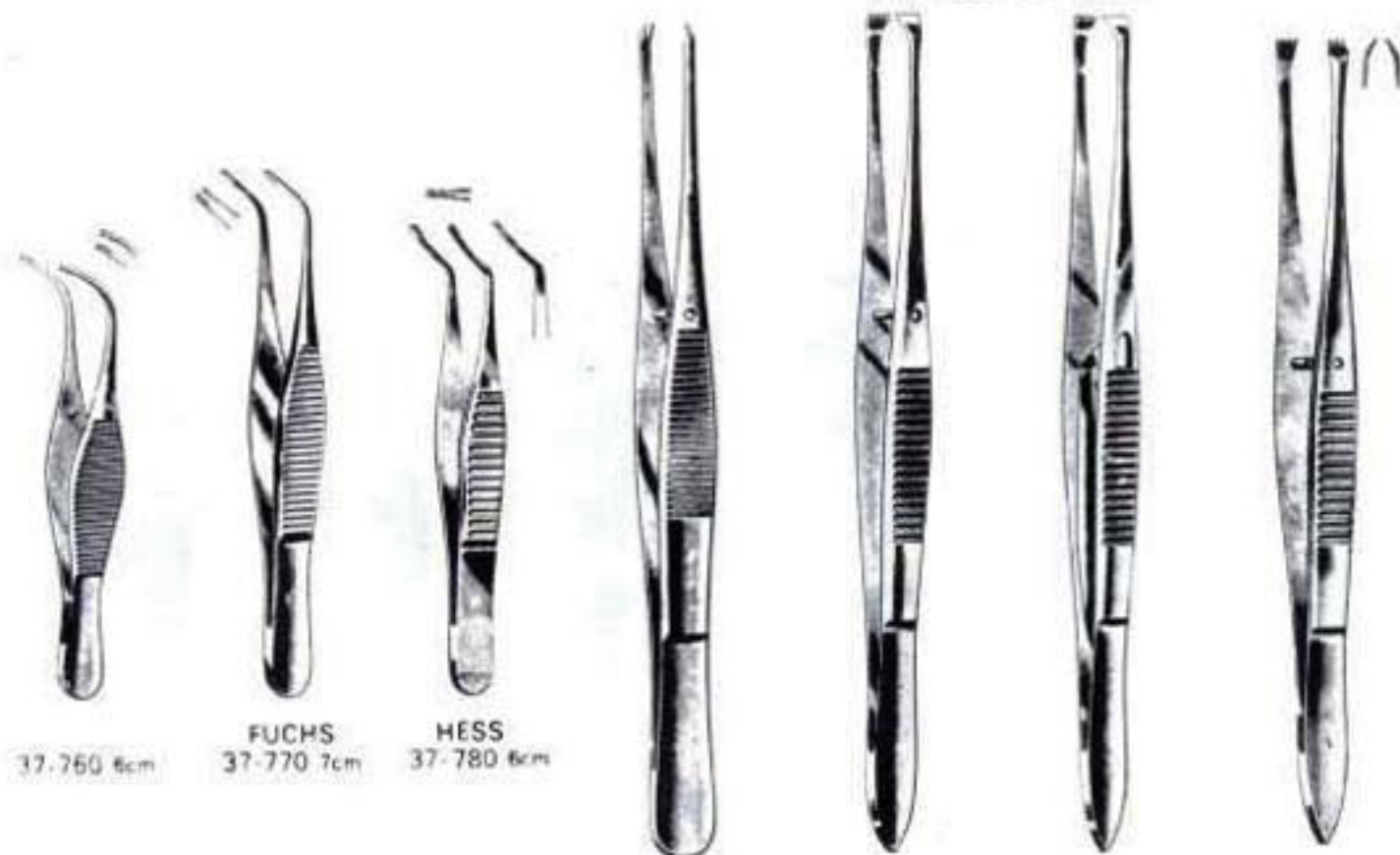

37-760 6cm

FUCHS 37-770 7cm

HESS 37-780 6cm

1:2 ELSCHING 37-750-11cm

GRAEFE 37-800 11cm

GRAEFE 37-810 11cm

SCHMIDT-RIMPLEX 37-820 11cm



OPHTHALMOLOGY

SUTURES AND CHALAZIAN FORCEPS

SUTURE FORCEPS

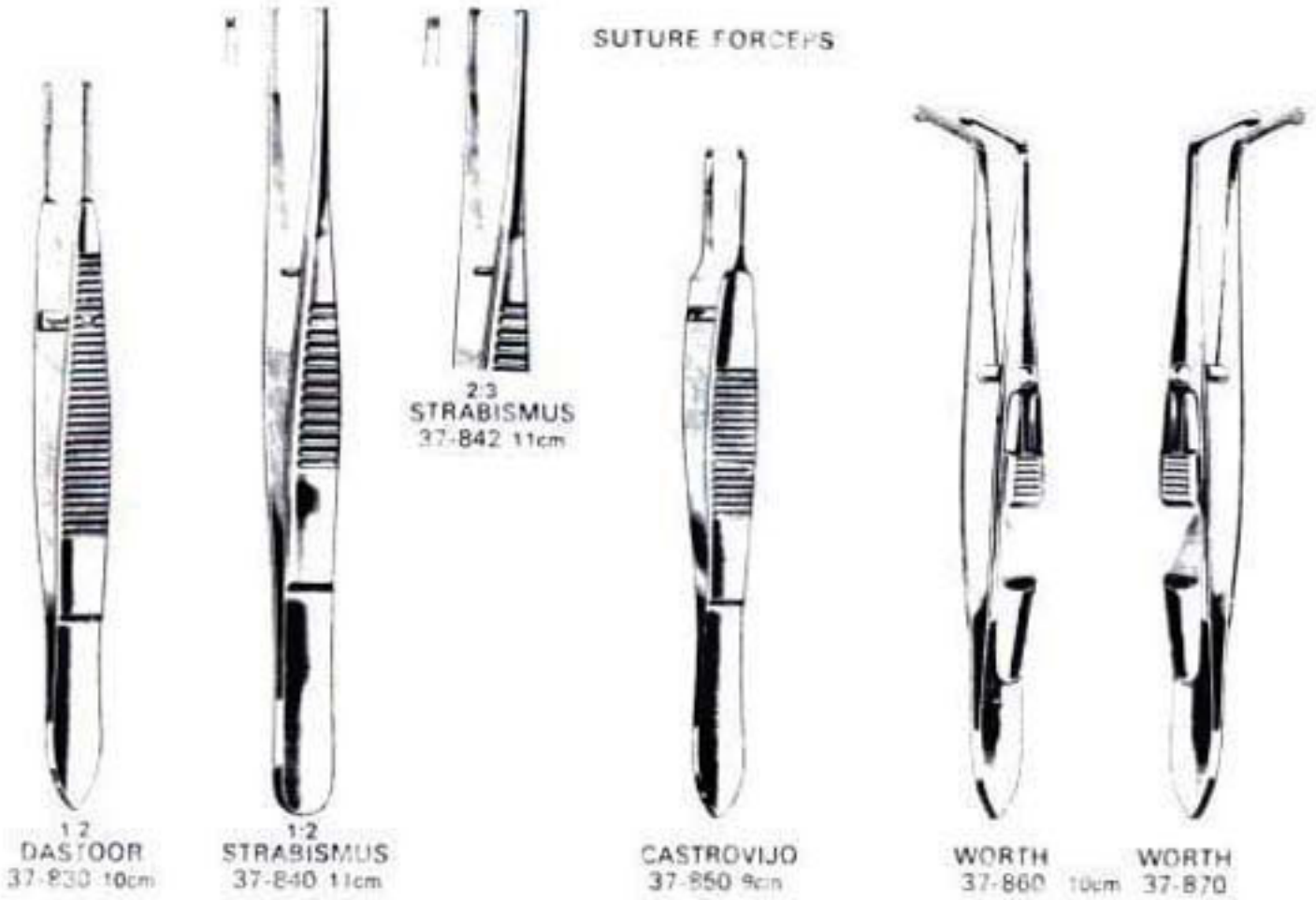

CHALAZIAN FORCEPS





OPHTHALMOLOGY ENTROPIUM FORCEPS



SNELLEN
37-910 R
37-912 L



DESMARRES
37-920 10cm 37-922



KNAPP
37-930 11cm

IRIS AND TENOTOMY SCISSORS



NOYES
37-940 12cm
37-942 12cm
37-944 12cm



37-940



37-942



37-944



WECKER
37-950 11cm
37-952 11cm
37-954 11cm



37-950



37-952



37-954



CASTROVIJO
37-960 10cm



OTOLOGY

EAR SPECULA



HARTMAN
39-100



TOYNBEE
39-110



GRUBER
39-120

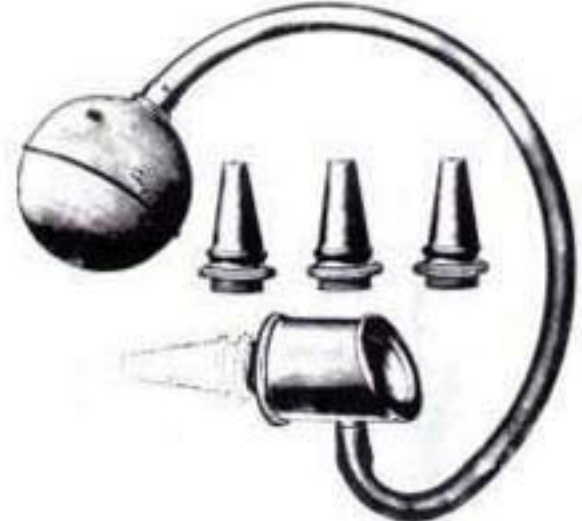

SIEGLE
39-130

PNEUMORY SYRINGE

- 39-140 50cc
- 39-142 75cc
- 39-144 100cc
- 39-146 150cc

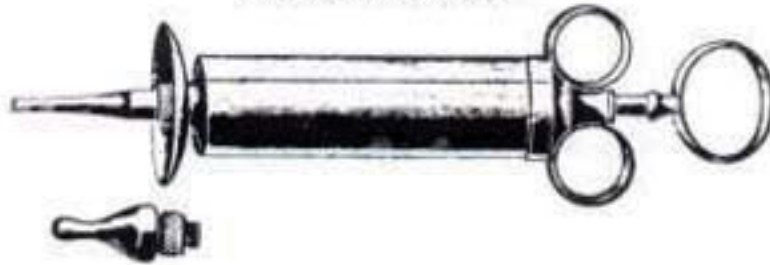

CATHETERS

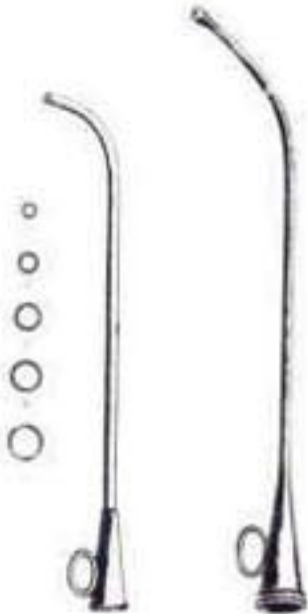

LUCAE
39-150
Fig 0 to 5

WOAKES
39-160

PERFORATORS

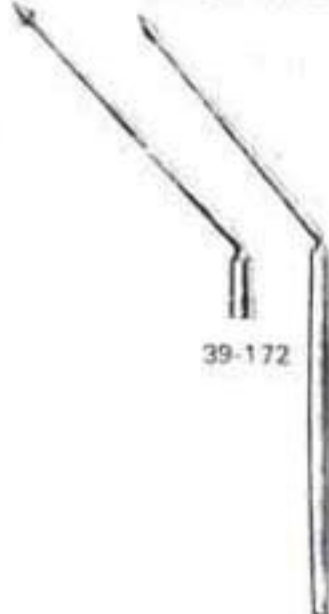

39-172

TROELTSCH
39-170
39-172

CURETTES



GROSS
39-180 39-190



BARKER
39-200



POLYPUS SNARES



KRAUSE
39-210



WILDE
39-220

EAR DERESSING FORCEPS



39-230 12cm

39-240 14cm

POLYPUS & FOREIGN BODY FORCEPS



QUIRE
39-250



HARTMANN
39-260 12cm



HARTMANN
39-270 14cm



YANKAUER
39-280 15cm



OTOLOGY EAR FORCEPS



HARTMANN



39-290 8.5cm
39-291 14cm
39-292 16.5cm



39-293 8.5cm
39-294 14cm

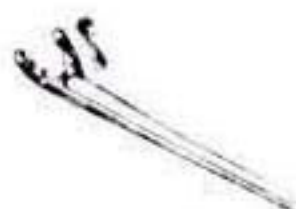

39-295 8.5cm



39-296 8.5cm



39-297 8.5cm



39-298 8.5cm



39-299 8.5cm



39-300 8.5cm

39-290 8.5cm
39-291 14cm
39-292 10.5cm
39-293 8.5cm
39-294 14cm

39-295 8.5cm
39-226 8.5cm
39-297 8.5cm
39-298 8.5cm
39-299 8.5cm

39-300 8.5cm



RHINOLOGY NAZAL SPECULA

NAZAL SPECULA



VIENNA
41-100 ADULT
41-102 CHILD
41-104 INFANT



KILLIAN
41-110 Fig 1.
41-112 Fig 2
41-114 Fig 3
41-116 Fig 4

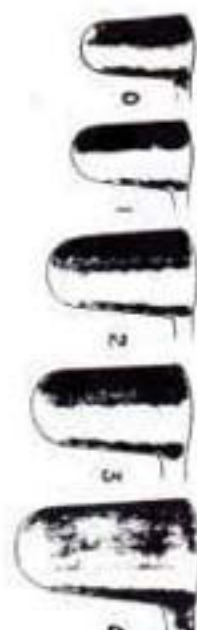

THUDICHUM
41-120 Fig 0
41-122 Fig 1
41-124 Fig 2
41-126 Fig 3
41-128 Fig 4

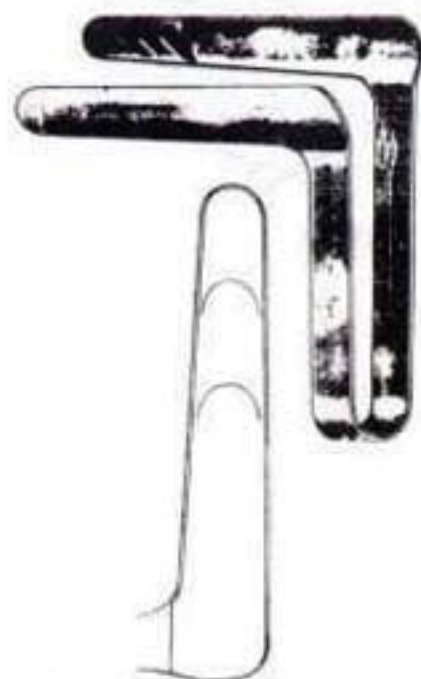

ST-CLAIR THOMSON
41-130 Fig 1
41-132 Fig 2
41-134 Fig 3



VOLTOLINI
41-140 Fig 1
41-142 Fig 2
41-144 Fig 3



YANKAUER
41-150 1 1/2 in



RHINOLOGY

NAZAL SNARE



LANGEWILDE
41-160



KRAUSE-VOSS
41-170

NAZAL DRESSING FORCEPS



TROELTSCH
41-180 18cm



JANSEN
41-190 20cm

NAZAL DRESSING FORCEPS

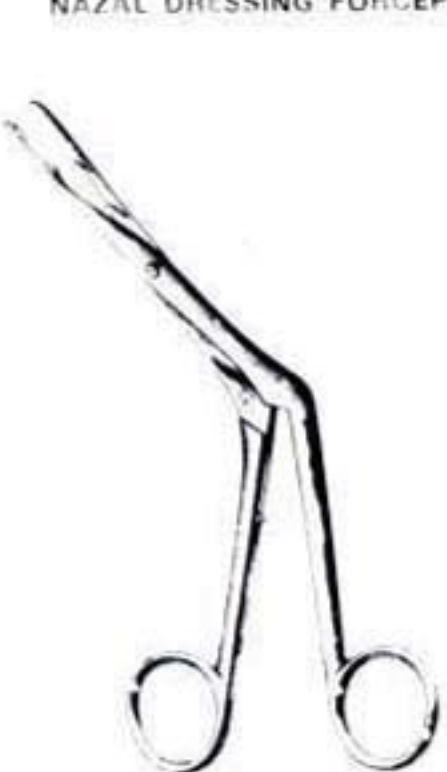

HEYMANN KNIGHT
41-200 18cm

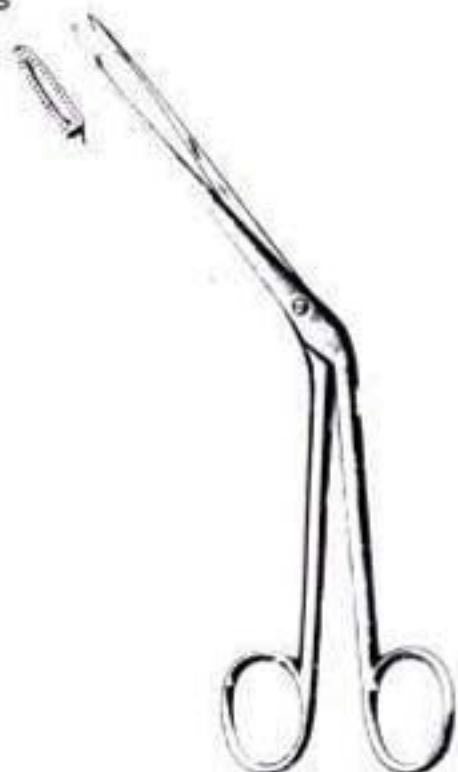

HARTMAN
41-210 20cm

NAZAL CUTTING FORCEPS



41-220



41-222

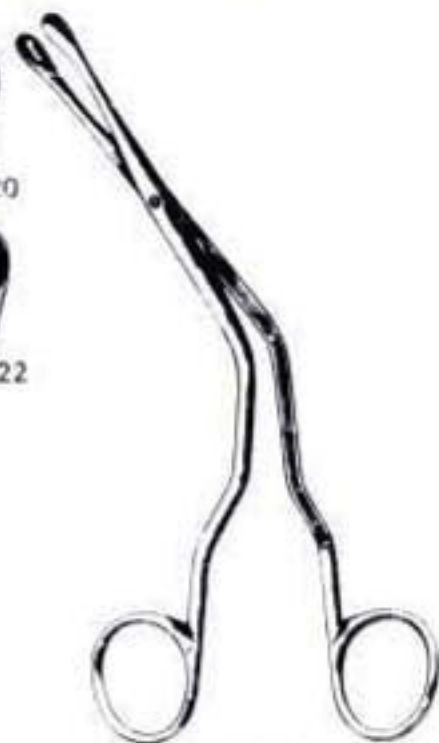

LUC
41-220 20cm
41-222 20cm



RHINOLOGY NAZAL CUTTING FORCEPS

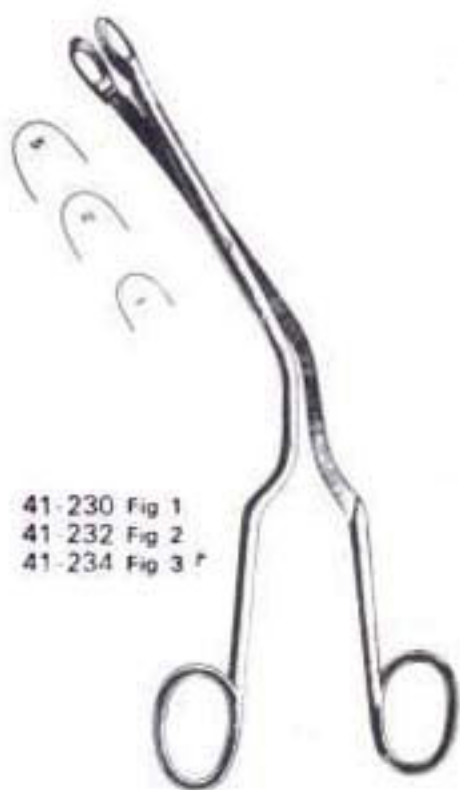

41-230 Fig 1
41-232 Fig 2
41-234 Fig 3 r

LUC
20cm



41-240



41-242



41-244



41-246



BRUENING
41-240 20cm
41-242 20cm
41-244 20cm
41-246 20cm



STRUYCKEN
41-250



STRUYCKEN
41-251



WEIL
41-255



TAKAHASHI
41-256



TAKAHASHI
41-257

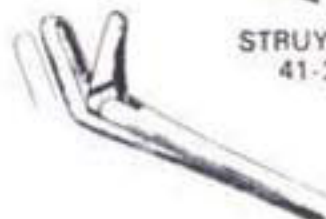

HAEK
41-252



MYLES
41-253



HARTMANN
41-254



STROYCKEN
41-250 19cm
41-251 19cm
41-252 19cm
41-253 19cm
41-254 19cm
41-255 19cm
41-256 19cm
41-257 19cm



RHINOLOGY
NAZAL CUTTING FORCEPS

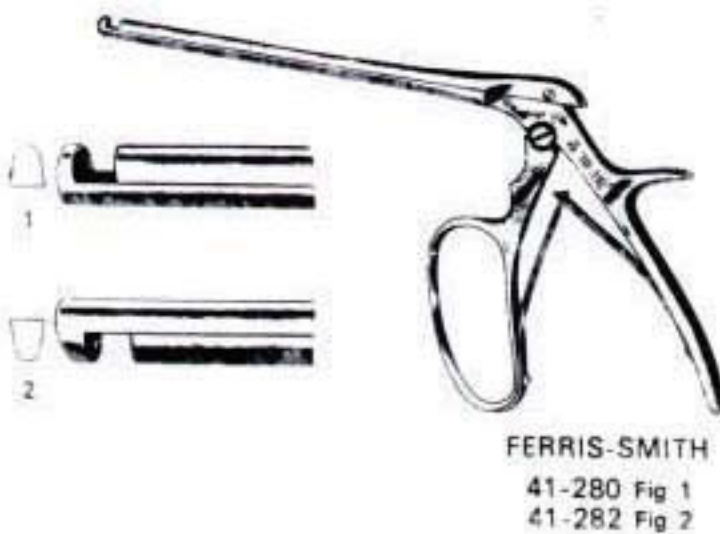
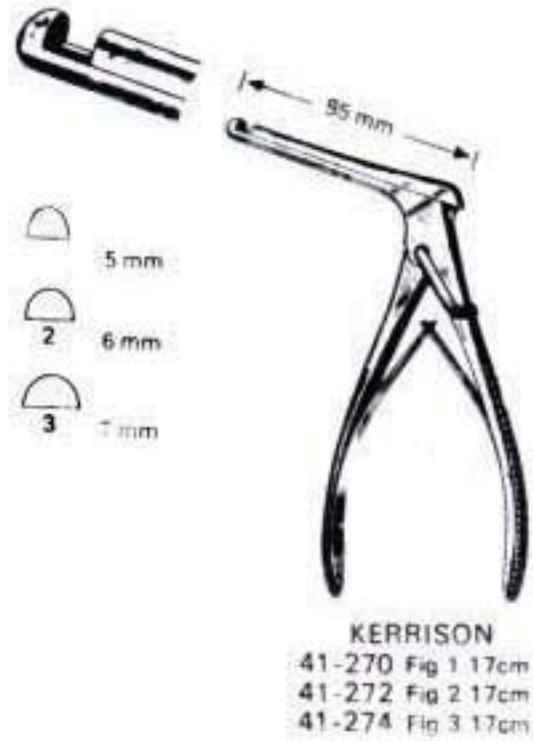
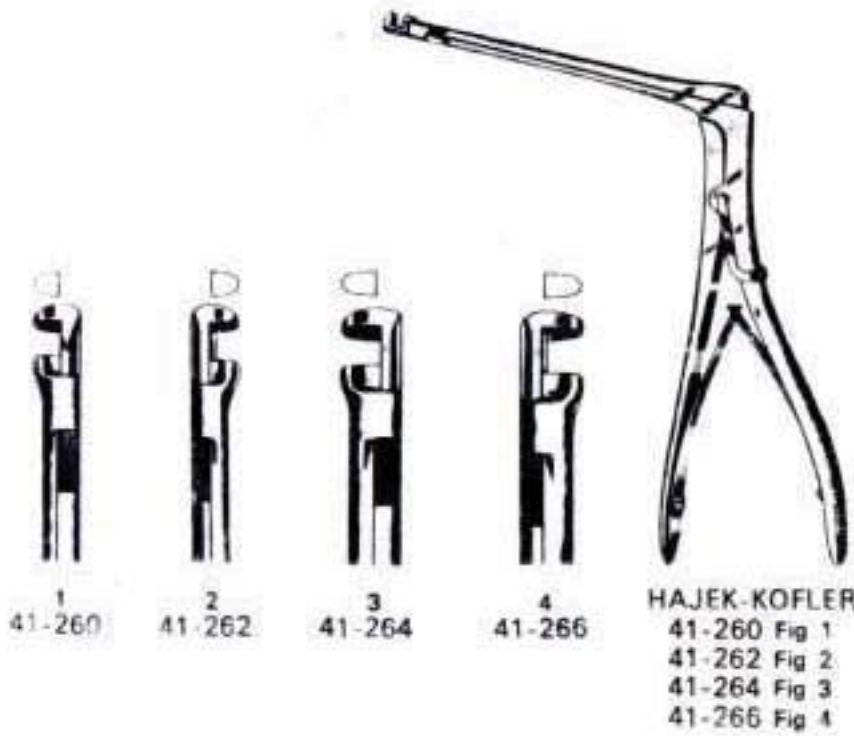



RHINOLOGY

SEPTUM FORCEPS



ASCH
41-300 23cm



L

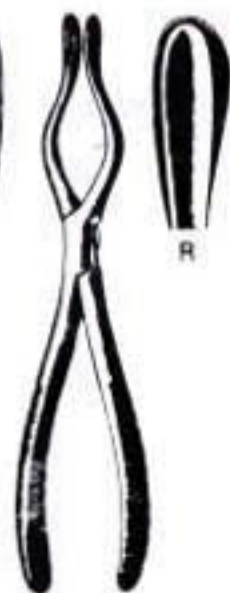

WALSHAM
41-310 23cm



R



WALSHAM
41-320 23cm

KNIVES



BALLENGER
41-330



BRUENINGS
41-340



FREER
41-350

CURETTES



MYLES
41-360 17cm
41-362 17cm
41-364 17cm
41-366 17cm
41-368 17cm



41-368



FREER
41-370



FREER
41-380



FREER
41-390

KNIVES



BALLENGER
19cm
41-400 3mm
41-402 4mm
41-404 5mm



41-400



41-402



41-404



RHINOLOGY

ELEVATORS



FREER
41-410

FREER
41-420



FREER
1-430 16.5cm

GOUGES



BALLENGER
16cm
41-440 4mm
41-442 6mm
41-444 9mm

KILLIAN
41-450 5mm

CHISELS



FREER
41-460

FREER
41-470

SINUS CANNULA



EICKEN-KILLIAN
41-480 3mm

KILLIAN
41-490 1.5cm

ANTRUM CANNULA



HARTMANN
41-500



HARTMANN
41-510 2 mm
41-512 2.5mm
41-514 3 mm



RHINOLOGY

ADENOID CURETTE

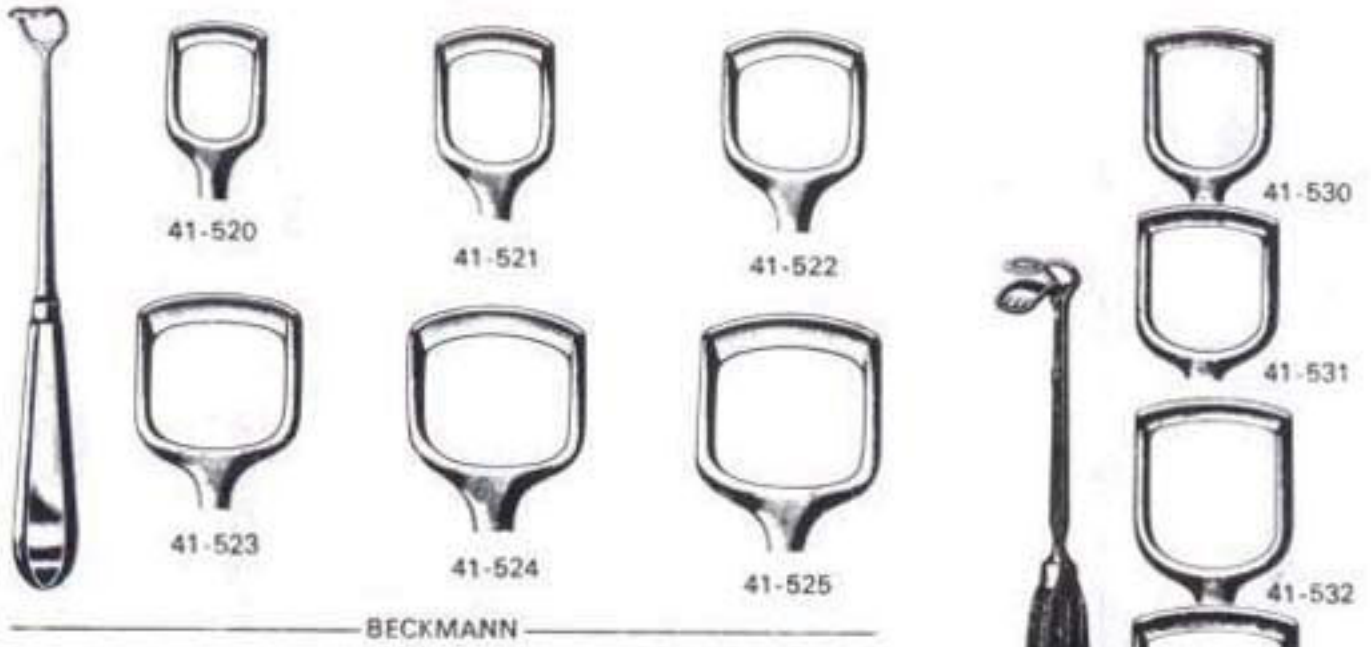

ST. CLAIR THOMSON



LA-FORCE



SAW



JOSEPH



ORAL INSTRUMENTS MOUTH GAGS



DOYEN
43-100 CHILD
43-102 ADULT



MOLT
43-110 14cm



FURGUSSON
43-120 15cm
43-122 19cm] P.JAWS
43-124 15cm
43-126 19cm] A.JAWS



MASON
43-130 15cm
43-132 19cm] P.JAWS
43-134 15cm
43-136 19cm] A.JAWS



ROSER-KONIG
43-140 16cm
43-142 19cm

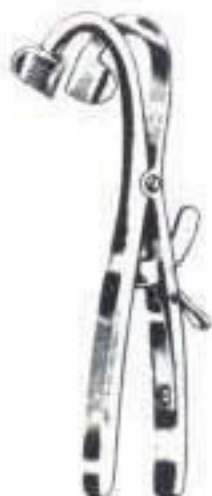

DENHART
43-150 12cm



BUXTON
43-160 A.JAWS
43-162 P.JAWS



HEISTER
43-170 13cm



ORAL INSTRUMENTS

MOUTH GAGS



HEISTER
43-180 12cm

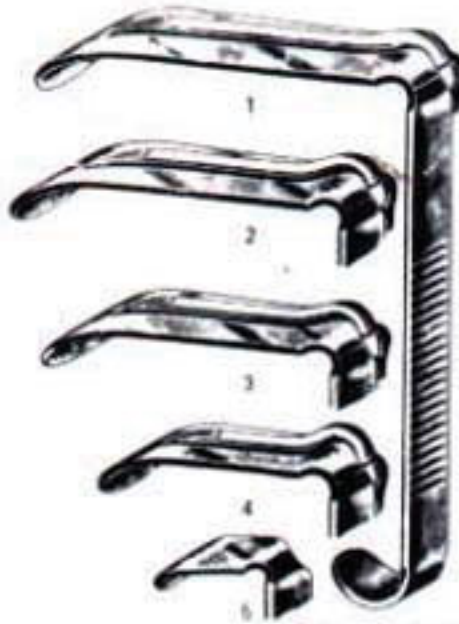

DAVIS-BOYLE
43-190 SET

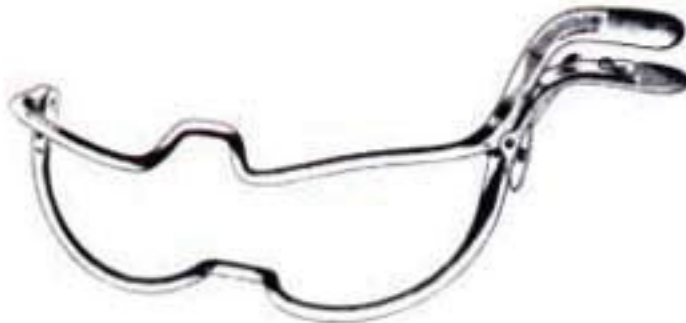

JENNING
43-200 9cm
43-202 11cm
43-204 13cm
43-206 15cm



WHITEHEAD
43-210 11cm
43-212 13cm
43-214 15cm

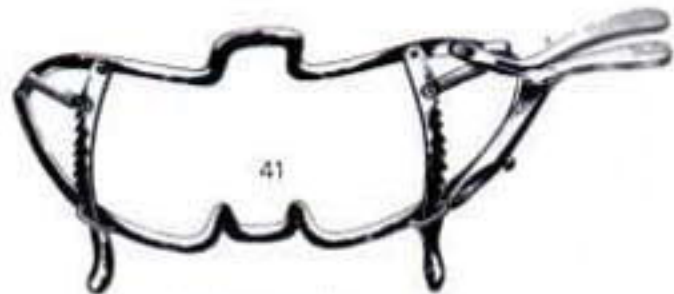

WHITEHEAD
43-220 11cm
43-222 13cm
43-224 15cm



ORAL INSTRUMENTS TONGUE DEPRESSORS



TOBOLD
43-228 12 cm



43-230 14.5cm



BRUENING
43-240 9cm



MAYO
43-250 17cm
43-252 19cm



BUCHWALD
43-260 18cm



WIEDER
43-270 Fig 1 14cm
43-272 Fig 2 15cm



LACK
43-280 CHILD
43-282 ADULT



BOSWORTH
43-290 14.5cm

TOBOLD
43-300 14.5cm



ORAL INSTRUMENTS TONGUE DEPRESSORS

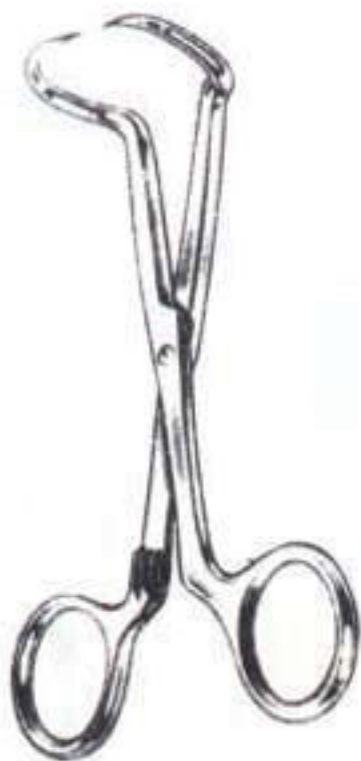

CARMALT
41-310 12.5cm

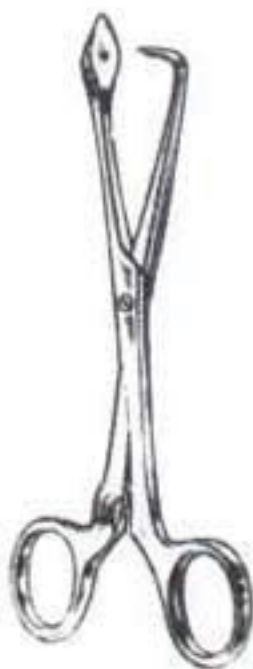

CARBOULD
43-320 14cm

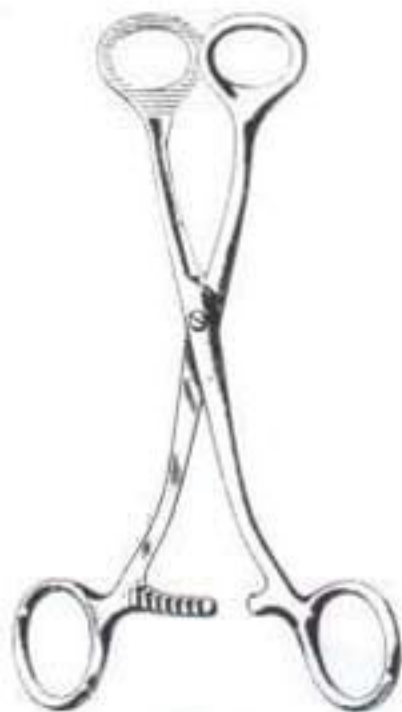

COLLIN
43-330 16cm
43-332 17cm
43-334 19cm



GUY
43-340 19cm



MATHIEU
43-350 19cm



43-360 17cm



YOUNG
43-370 16cm



TONSIL

DISSECTORS

KNIVES

TONSIL FORCEPS

NEEDLES

BROPHY
45-100 19cm

LYNCH
45-110 20cm

DUPUY-WEISS
45-120 22cm 45-122

HURD 45-130 22.5cm
WEIDER 45-140 21.5cm

TIVNEN-TYDING
45-150 Fig 1 22cm
45-152 Fig 2 22cm

TONSIL FORCEPS



WHITE
45-160 18cm
45-162 23cm



COLVER
45-170 19cm



BALLENGER
45-180 21.5cm

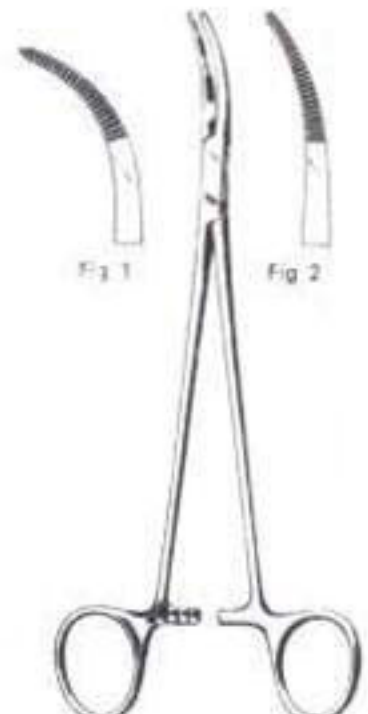

SAWTELL-SCHMIDT
45-190 Fig 1 18cm
45-192 Fig 2 18cm



SNARES

TONSIL



EVES
45-200 28cm



EVES
45-210 28cm



EVES
45-220 28cm



BRUENING
45-230 28cm

PUNCH FORCEPS



HARTMANN
45-240 13mm
45-242 15mm
45-244 17mm

GUILLOTINES

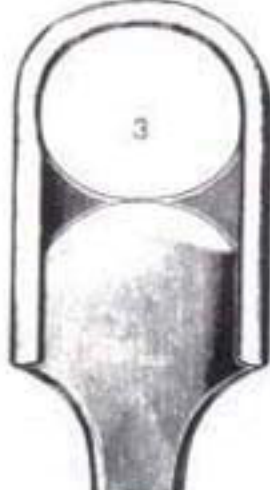
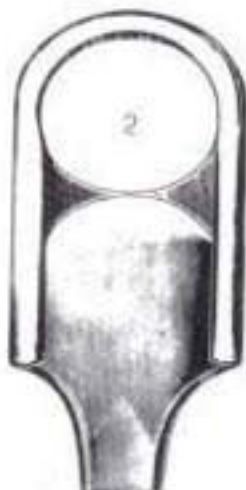

SLUDER-BALLENGER
45-250 SET
45-252 Fig 1
45-254 Fig 2
45-256 Fig 3



**ESOPHAGOSCOPY
 LARYNGEAL FORCEPS**



FRAENKEL
 47-100 18cm

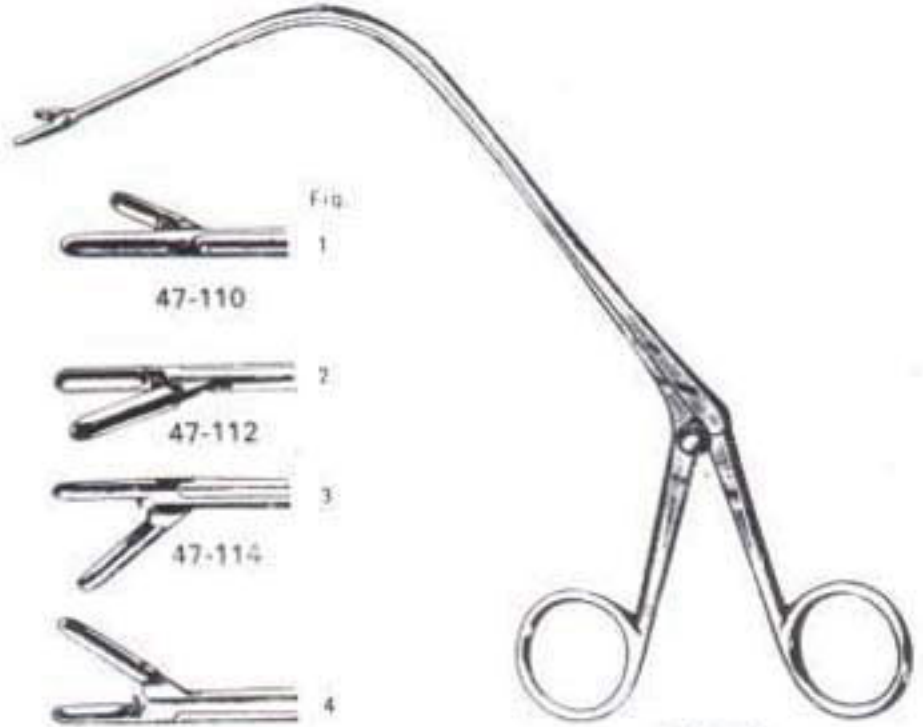

JURASZ
 47-110 19cm
 47-112 19cm
 47-114 19cm
 47-116 19cm



CHEVALIER-JACKSON

| | 40cm | 50cm | 60cm |
|-------|--------|--------|--------|
| Fig 1 | 47-120 | 47-130 | 47-140 |
| Fig 2 | 47-121 | 47-131 | 47-141 |
| Fig 3 | 47-122 | 47-132 | 47-142 |
| Fig 4 | 47-123 | 47-133 | 47-143 |
| Fig 5 | 47-124 | 47-134 | 47-144 |
| Fig 6 | 47-125 | 47-135 | 47-145 |
| Fig 7 | 47-126 | 47-136 | 47-146 |

HANDLES

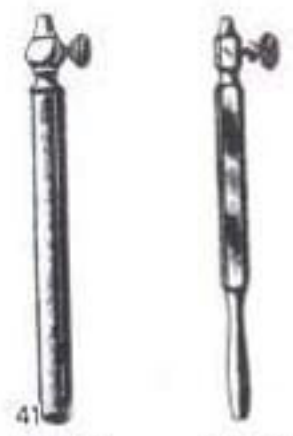

41
 47-150

41
 47-160



TRACHEOTOMY

FRACHAEL HOOKS

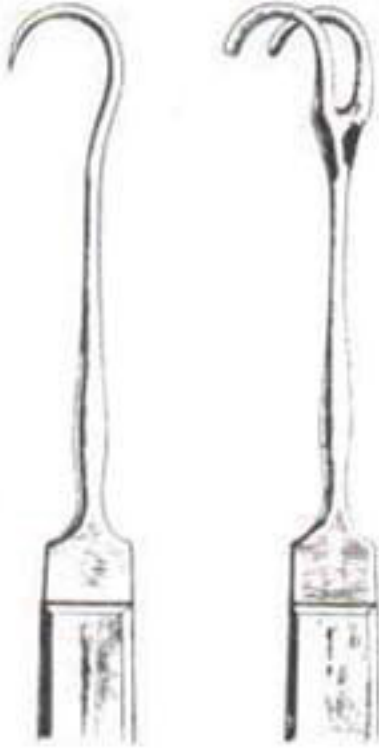

49-100

49-110

DILATING FORCEPS

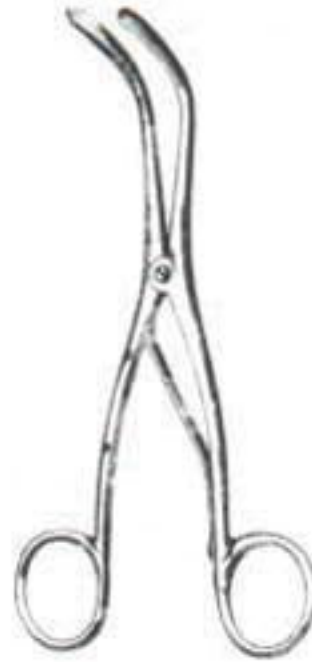

TROUSSEAU

49-120 10.5cm

49-122 14 cm



LABORDE

49-130 14cm

TRACHEAL TUBES

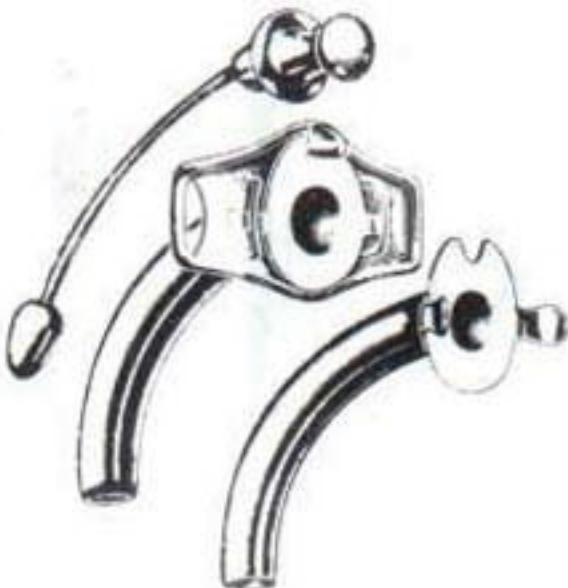

JACKSON

49-140

4 To 13mm



FULLER

49-150

18 To 32 F.G.



CUBLEY

49-160

18 To 32 F.G.



INTESTINES and STOMACH

GOITRE FORCEPS



LAHEY
51-100 15cm
51-102 20cm

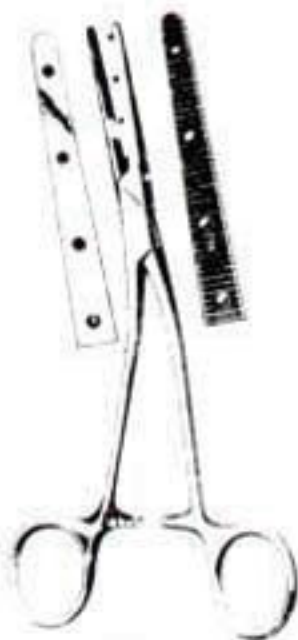

MASTIN
51-110 17cm

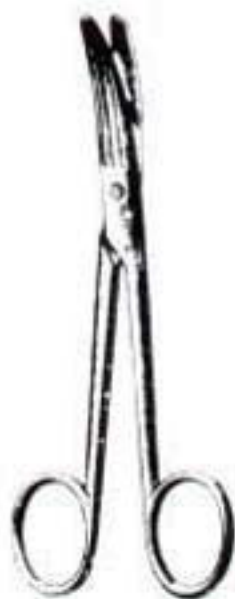

SCHOEMAKER
51-120 15cm

ENACULATORS



KOCHER
15-130 16cm



KOCHER
51-140 15cm

HOOKS



GILLIES
18cm
51-180 Fig 1
51-182 Fig 2



KILNER
51-170 15cm



UNNA
51-160 14cm



UNNA
51-150 14cm

TISSUE FORCEPS

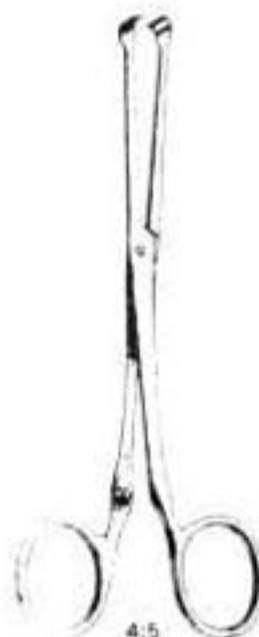

ALLIS
51-190 15cm



ALLIS
51-200 4.5 15cm
51-202 5.6 15cm

EXTRACTORS



INTESTINES AND STOMACH INTESTINAL FORCEPS



ALLIS
51-210 20cm



LOCKWOOD
51-220 20cm



ALLIS-ADAIR
51-230 15.5cm



LOCKWOOD-ALLIS
51-240 18cm
51-242 20cm



JUDD-ALLIS
51-250 15cm
51-252 19cm



LITTLEWOOD
51-260 19cm



STILLE
51-270 20cm



LANE
51-280 12.5cm
51-282 15 cm
51-284 19 cm



INTESTINES AND STOMACH INTESTINAL FORCEPS



LANE
51-290 12.5cm
51-292 15 cm
51-294 19 cm



BOBCOCK
51-300 16cm
51-302 18cm
51-304 20cm
51-306 24cm



PORRIER
51-310 12.5cm
51-312 18 cm



PERCY
51-320 24cm



DENNIS-BROWN
51-330 18cm

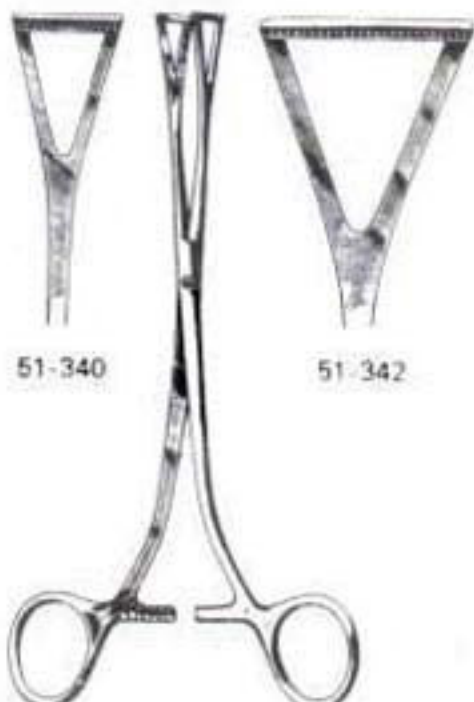

51-340

51-342

DUVAL-COLLIN
51-340 18cm
51-342 20cm

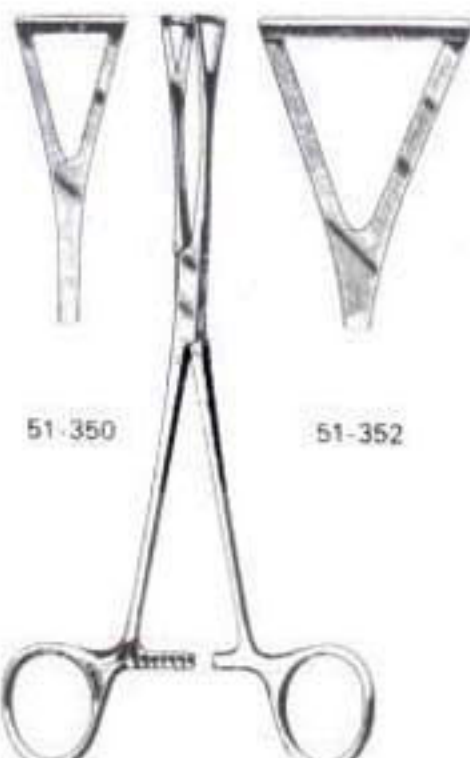

51-350

51-352

COLLIN
51-350 20cm
51-352 23cm



INTESTINES AND STOMACH INTESTINAL FORCEPS



STR DOYEN CUR
51-360 23CM 51-362

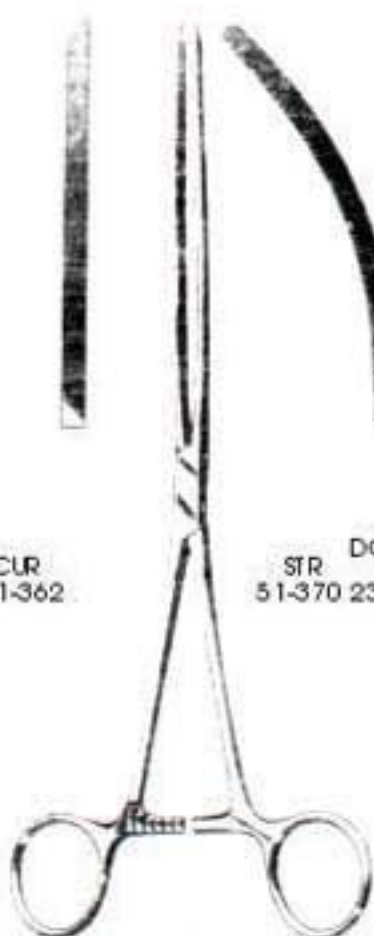

STR DOYEN CUR
51-370 23CM 51-372

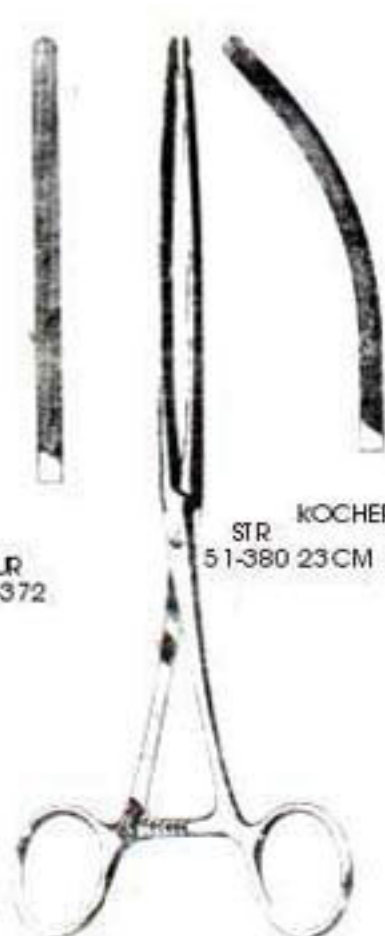

STR KOCHER CUR
51-380 23CM 51-382



51-390

KOCHER

51-390 25cm 51-400
51-392 26cm 51-402

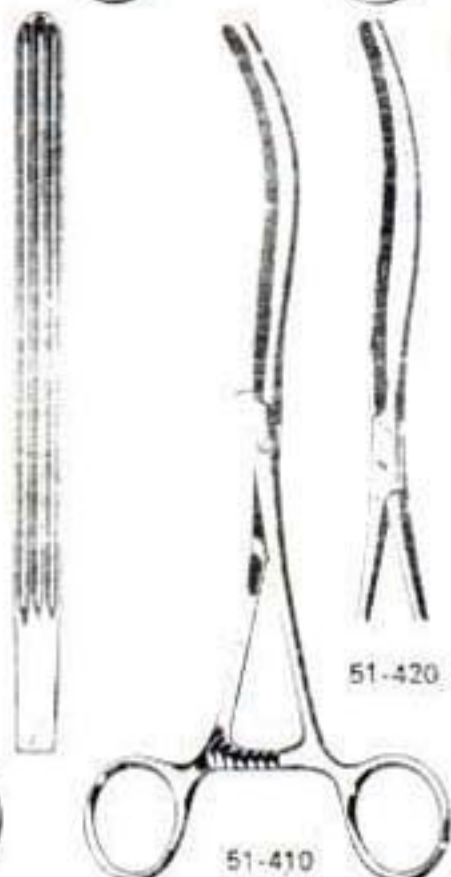

51-410

KOCHER

51-410 25cm 51-420
51-412 26cm 51-422

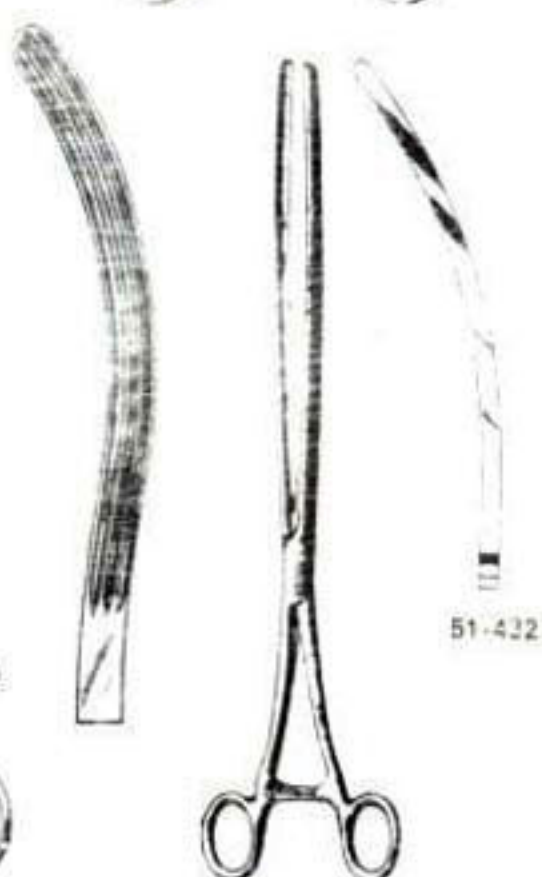

51-432

SCUDDER

51-430 33cm
51-432 33cm



INTESTINES AND STOMACH INTESTINAL FORCEPS

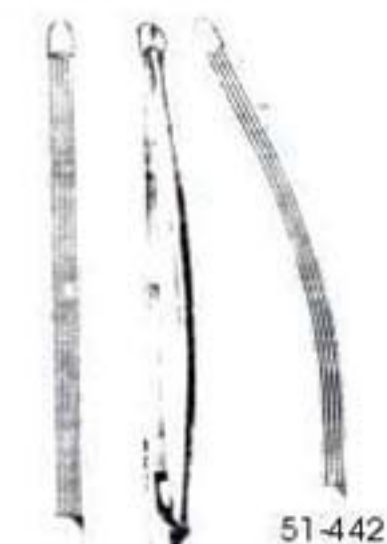

51-440

51-442

NUSSBAUM
51-440 25 CM
51-442-25CM

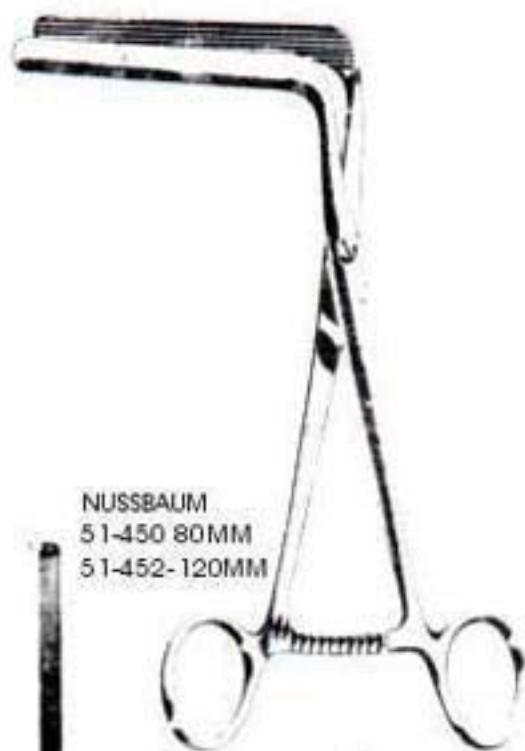
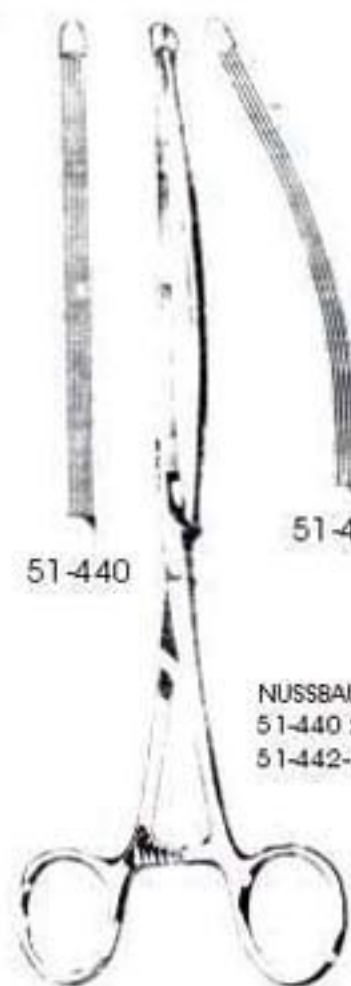

NUSSBAUM
51-450 80MM
51-452-120MM

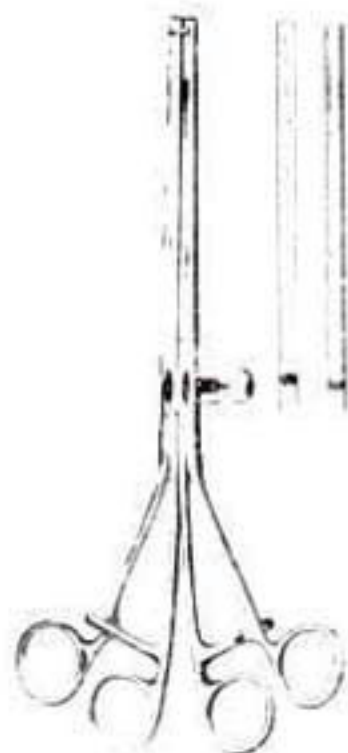

LANE
51-460 30CM

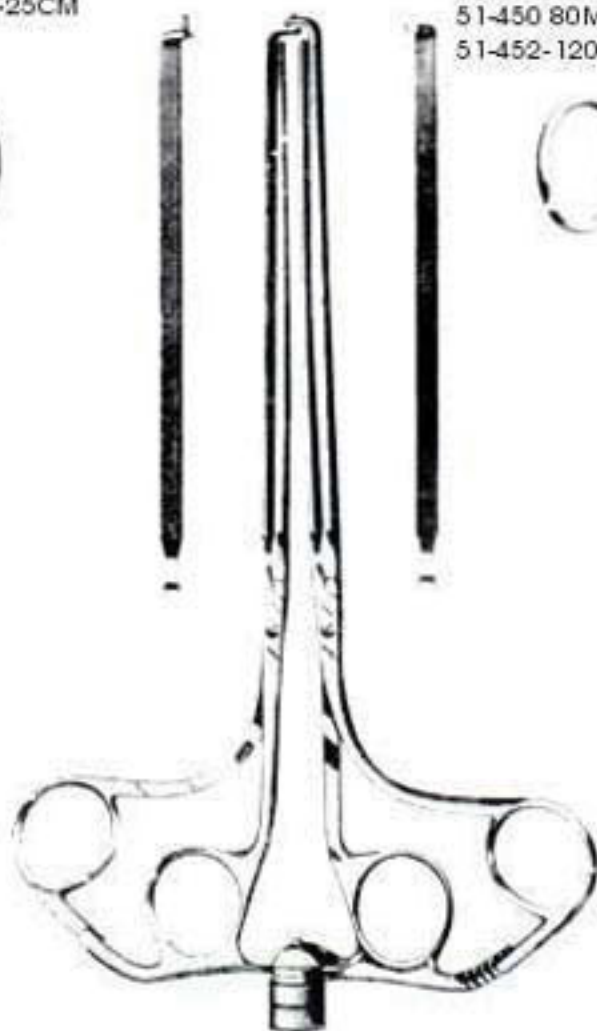

ABDIE
51-470 22cm
51-472 27cm



LANE
51-480 30cm



INTESTINES AND STOMACH INTESTINAL AND STOMACH CLAMPS



LANE
51-490 30cm



PAYR
51-500 15cm

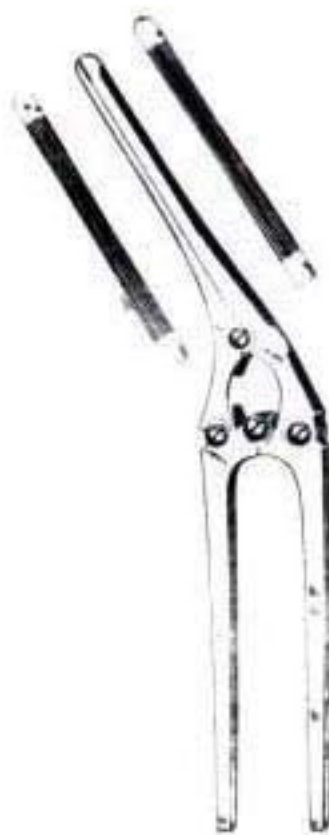

PAYR
51-510 21cm

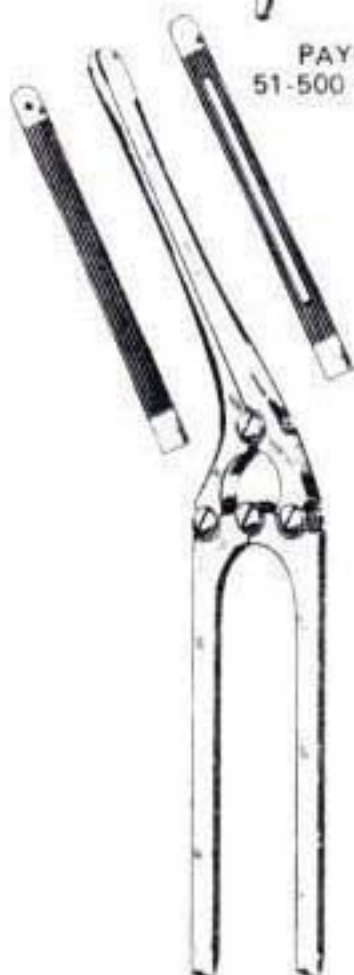

PAYR
51-520 29cm
51-522 35cm

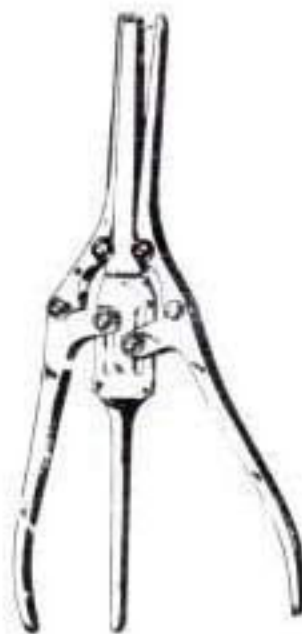

RANKIN
51-530 22cm



RECTUM

RECTAL SPECULA



SIMS
53-100 15cm



SIMS
53-110 15cm



SIMS
53-115 15cm



MATHIEU
53-120 19cm



KELLY
53-130 21x 50mm
53-131 27x 50mm
53-132 22x 50mm
53-133 22x100mm
53-134 22x140mm
53-135 22x200mm



GABRIEL
53-140 64x24mm
53-142 49x19mm



NAUTON-MORGAN
53-150 70x22mm



RECTUM

BIOPSY FORCEPS

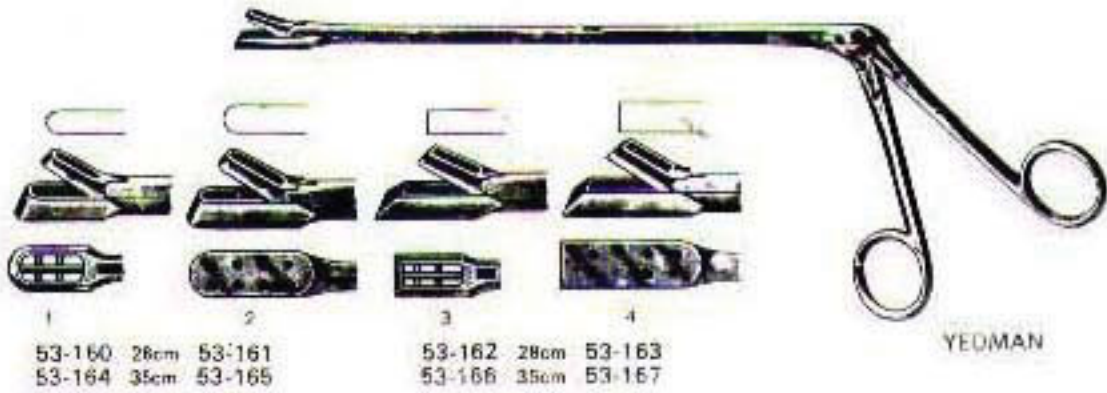

COTTON CARRIER

PILE FORCEPS

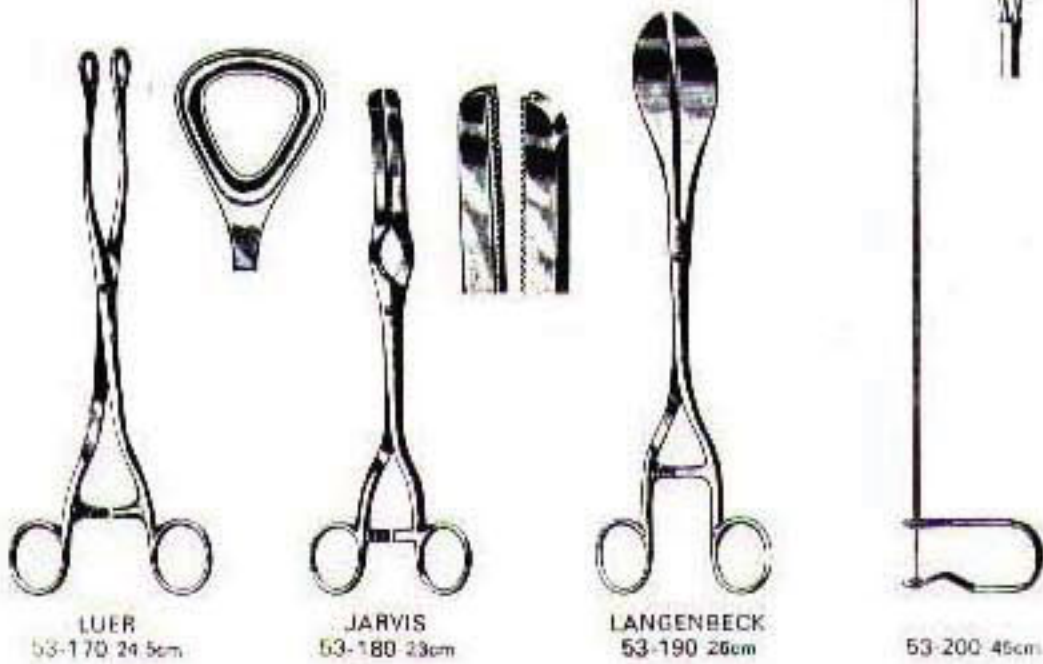



GALL BLADDER

DILATORS



BAKES
55-100 30cm Set
Fig 1 To 13



Fig 1



2



3



4



5



6



7



8



9



10



11



12



13

SCOOPS



4



DESJARDIN
30cm
55-110 Fig 1
55-112 Fig 2
55-114 Fig 3
55-116 Fig 4



MAYO
55-120 28cm

GALL STONE FORCEPS

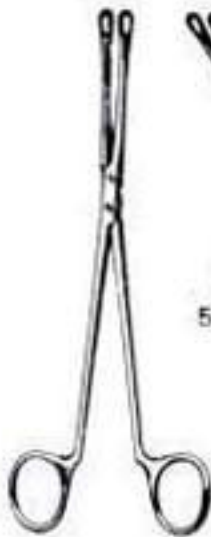

BLAKE
55-130 20cm
55-132 20cm



55-132



MAYO-BLAKE
55-140 20cm



DESJARDIN
23cm
55-150 Fig 1
55-152 Fig 2



GALL BLADDER

KIDNEY FORCEPS

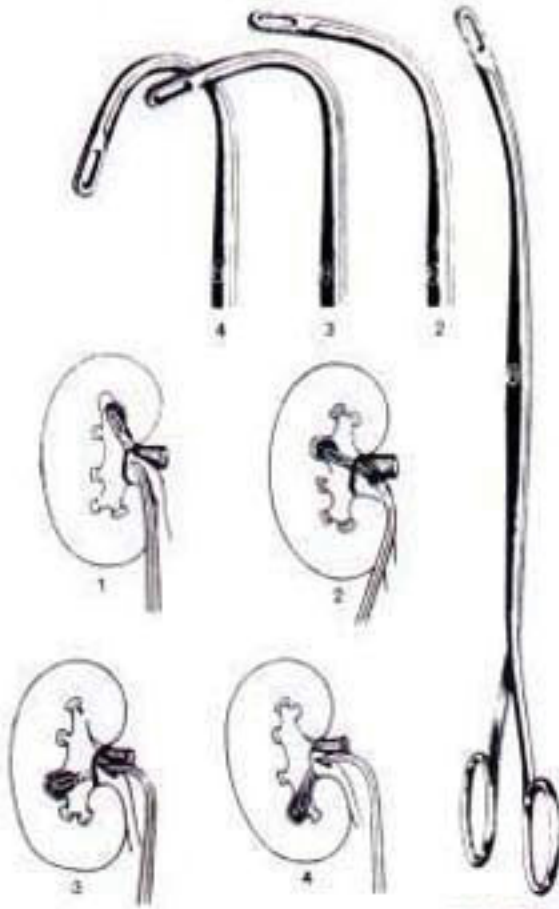

RANDALL
55-160 Fig 1 23cm
55-162 Fig 2 22cm
55-164 Fig 3 22cm
55-166 Fig 4 22cm

PROBE



MAYO
55-170 32cm

CATHETERS



MERCIER
57-100 33cm
8 FG To 24 Fg

UROLOGY CATHETERS



COXETER
57-110 28cm
8 FG To 24 FG



57-120 15cm
10 FG To 20 FG



57-130 20cm
8 FG To 24 FG



UROLOGY

URETHRAL BOUGIES



LISTER
57-140
00/1 To 15/18



CLUTTON
57-150
6 FG. To 28 F.G.



STONE
57-160
6 EG To 12 EG



WHEELHOUSE
57-170

DIRECTORS



CHILD
57-180



KEY
57-190

LITHOTOMY FORCEPS



LEWKOWITZ
57-200 26cm
57-202 26cm



57-202 26cm



YOUNG
57-210 20cm



UROLOGY

RETRACTORS



LEGUEU
57-220



MILLIN
57-230



MILLIN
57-240

SUCTION TUBE



MILLIN
57-250

URETHRAL FOREIGN BODY FORCEPS

PROSTATECTOMY FORCEPS



MILLIN
57-280 23cm



57-270 23cm



MILLIN
57-290 23cm

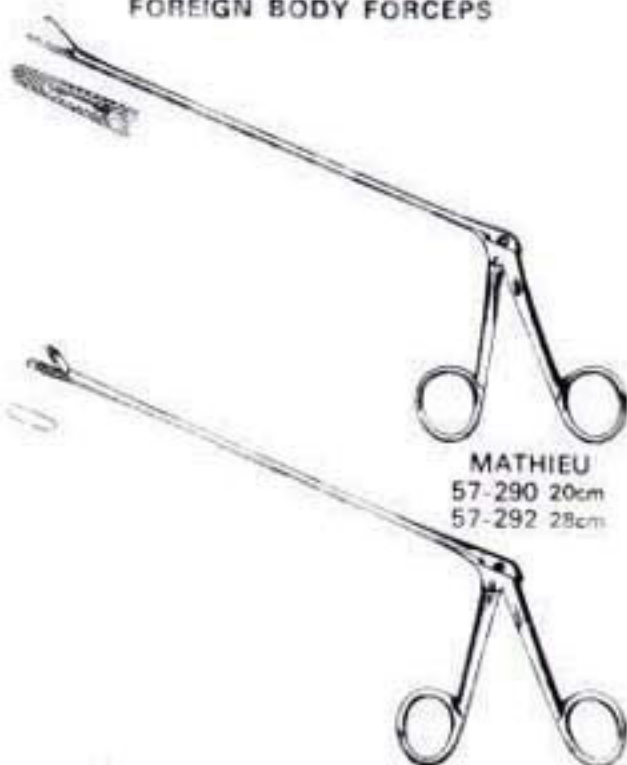

MATHIEU
57-290 20cm
57-292 28cm

MATHIEU
57-300 20cm
57-302 28cm



GYNECOLOGY VAGINAL SPECULA



CUSCO
61-100 SMALL
61-102 MEDIUM
61-104 LARGE



CUSCO
61-110 SMALL
61-112 MEDIUM
61-114 LARGE



GRAVES
61-120 SMALL
61-122 MEDIUM
61-124 LARGE



COLLIN
61-130 SMALL
61-132 MEDIUM
61-134 LARGE



SIMS
61-140 SMALL
61-142 MEDIUM
61-144 LARGE



GYNECOLOGY VAGINAL SPECULA



KRISTELLER
61-150 SMALL
61-152 MEDIUM
61-154 LARGE

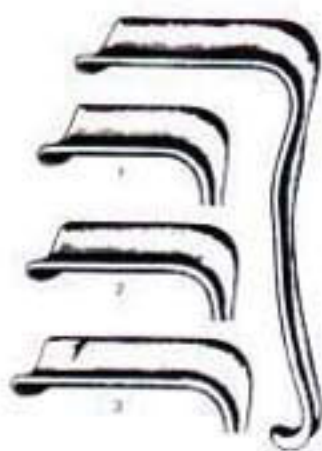

JACKSON
61-160 SMALL
61-162 MEDIUM
61-164 LARGE

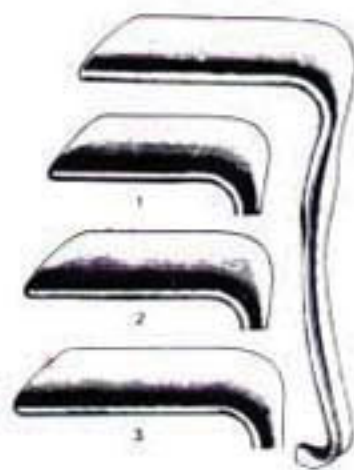

EASTMAN
61-170 SMALL
61-172 MEDIUM
61-174 LARGE



KALLMORGEN
61-180 90x40mm

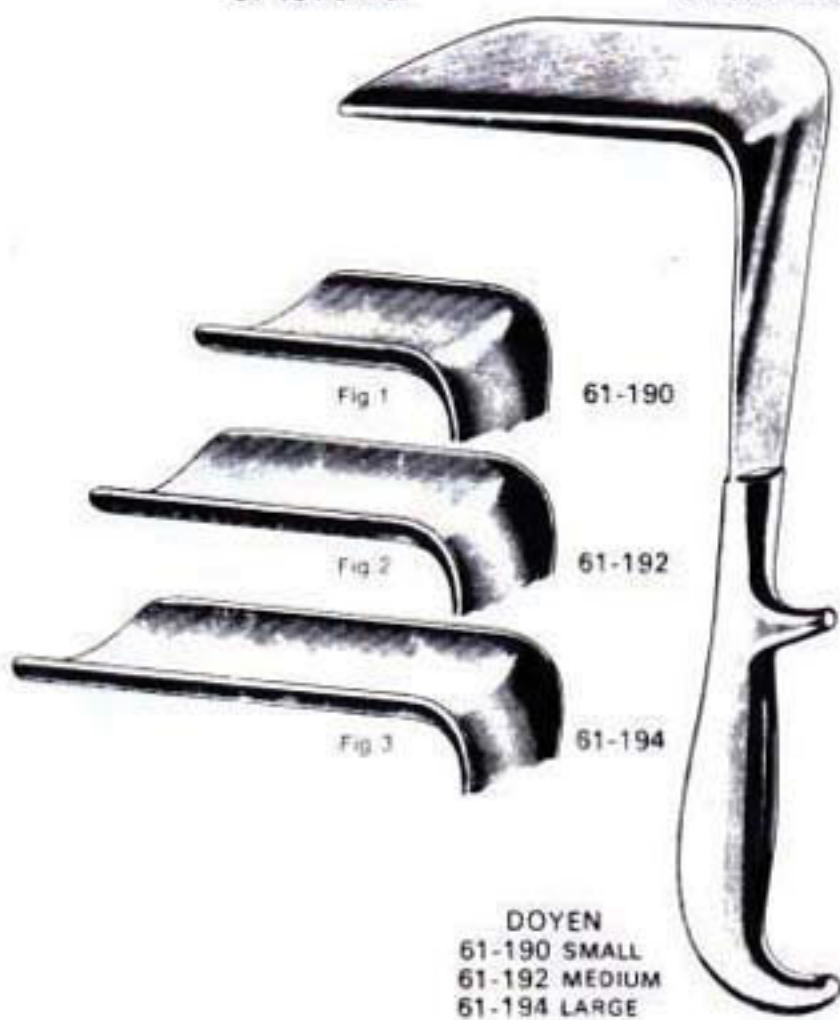



GYNECOLOGY VAGINAL SPECULA



AUVARD
61-200 2½ Lbs
61-202 3 Lbs



AUVARD
61-210 3 Lbs



AUVAND
61-220 2½ Lbs
61-222 3 Lbs



65 x 30mm
75 x 35mm
85 x 35mm
95 x 35mm



85 x 30mm
85 x 33mm
100 x 38mm
110 x 42mm



BOZEMANN
61-230



BOZEMANN
61-240



BREISKY
61-250 100x20mm
61-251 100x25mm
61-252 100x30mm
61-253 100x35mm
61-254 100x40mm



LANDAU
61-260 100x28mm
61-262 100x38mm



FREDMANN
61-270 10cm



**GYNECOLOGY
UTERINE DILATORS**



HEGAR
61-280 SET OF 14
4mm To 17mm

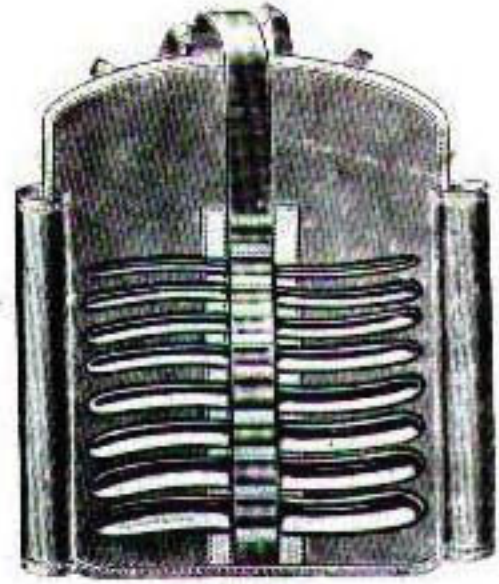

HEGAR
61-290 SET OF 8
3/4 To 17/16



HANK
61-300 SET OF 5
8/10 TO 18/20



HAWKINS-AMBER
61-310 SET OF 2
3-6 To 19-21



JOLLY
61-320 SET OF 5
3-7 To 12-15



GYNECOLOGY UTERINE DILATORS



WYLIE
29 cm
61-330 SERATED
61-332 SMOOTH



GOODELL
61-340 34cm



SIMS
61-350 28cm

DEPRESSORS



BRAUN
61-360 28cm

UTERINE SOUNDS



SIMS
61-380 26cm



SIMS
61-390 32cm



MARTIN
61-400 32cm



GALABIN
61-410 32cm



HORROCKS
61-420 32cm



SIMPSON
61-430 32cm



GYNECOLOGY TENACULUM FORCEPS



SCHROEDER
61-440 25cm



SCHROEDER
61-450 25cm



STAUDE-MODRE
61-460 17cm



SKENE
61-470 23cm



BRAUN
61-480 25cm



SKENE
61-490 24cm



POZZI
61-500 25cm

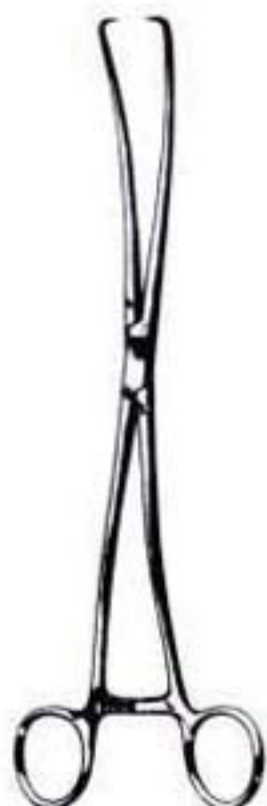

DUPLAY
61-510 28cm



GYNECOLOGY VULSELLUM FORCEPS



TEALE
61-520 18cm
61-522 23cm



TEALE
61-530 23cm



SCHROEDER
61-540 24cm
61-542 24cm
61-544 24cm



61-542



61-544



SKENE
61-550 23cm



MUSEUX
24 cm

| STH | L.I.H |
|-------------|--------|
| 61-560 6mm | 61-570 |
| 61-562 8mm | 61-572 |
| 61-564 10mm | 61-574 |



6mm

8mm

10mm



MUSEUX
26 cm

| | |
|-------------|--------|
| 61-580 9mm | 61-590 |
| 61-582 11mm | 61-592 |
| 61-584 11mm | 61-594 |



9 mm



11 mm



13 mm



GYNECOLOGY

VULSELLUM FORCEPS



MUSEUX

STR 24 cm CUR
61-600 6mm 61-610
61-602 8mm 61-612
61-604 10mm 61-614



HENROTIN

61-620 20.5cm



JACOBS

61-630 21cm
61-632 21cm



PRATT

61-640 28cm

HYSTERECTOMY FORCEPS



MAINGOT

61-650 20cm
61-652 24cm



BONNEY-BERKELEY

61-660 19cm



BONNEY

61-670 27cm



BONNEY

61-680 35cm



GYNECOLOGY

POLYPUS FORCEPS



NOTO
61-690 27cm



KELLY
61-700 32cm

ELEVATING FORCEPS



DARTIGUES
61-710 27cm



COLLIN
61-720 25cm

BIOPSY



SOMER
61-730 23cm



THOMAS-GAYLOR
61-740 22cm
61-742 24cm



SCHUBERT
61-750 26cm



GYNECOLOGY
UTERINE BIOPSY FORCEPS



FAURE
61-760 24cm



WITTNER
61-770 23cm

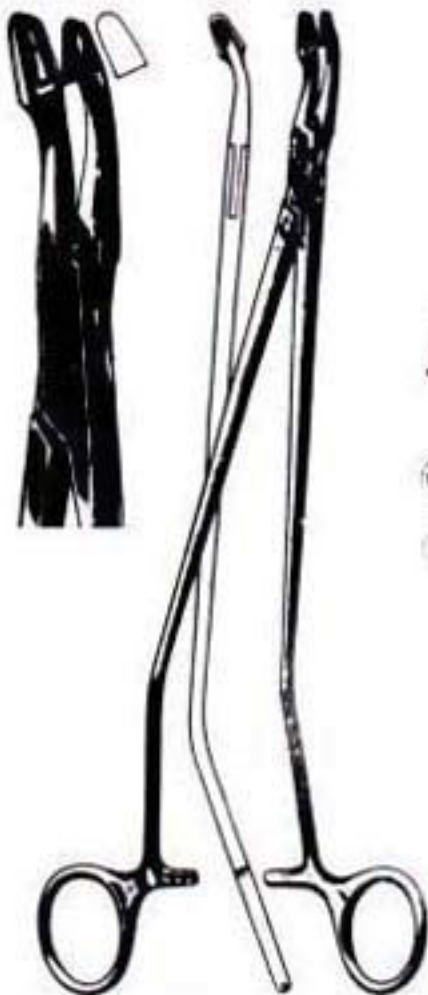

VAN-DOREN
61-780

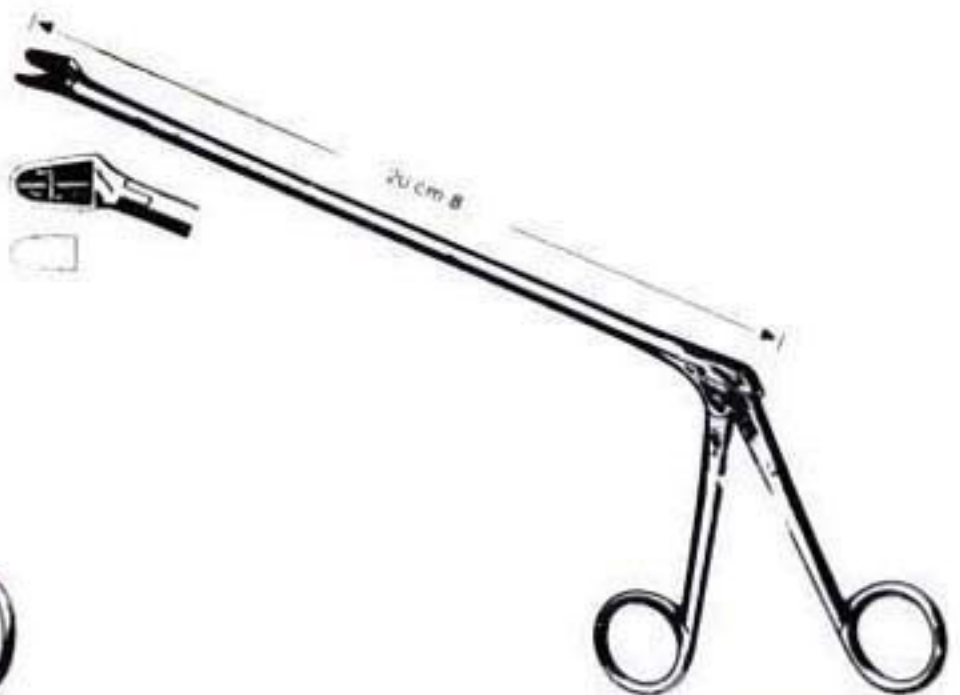

ALEXANDER
61-790 28cm



GYNECOLOGY UTERINE CURETTES



BLAKE
61-800 27cm

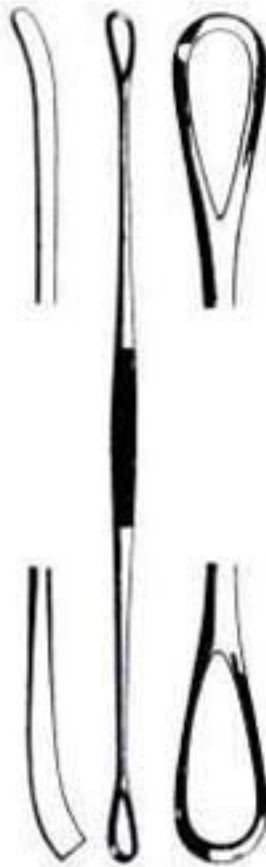

ZWEIFEL
61-810 31cm



SIMS
25cm



61-820 Fig 1 61-823 Fig 4
61-821 Fig 2 61-824 Fig 5
61-822 Fig 3 61-825 Fig 6



RECAMIER 26cm **RECAMIER** 31cm

61-830 SHARP Fig 1 to 10 61-850
61-840 BLUNT Fig 1 to 10 61-860





GYNECOLOGY UTERINE CURETTES



SIMS
25cm

61-870 SHARP Fig 1 to 6
61-880 BLUNT Fig 1 to 6

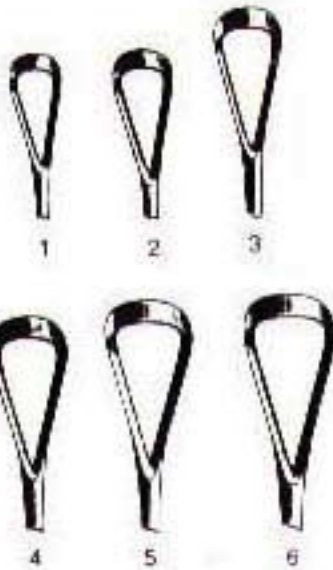

THOMAS
28cm

61-890 SHARP Fig 1 to 6
61-900 BLUNT Fig 1 to 6

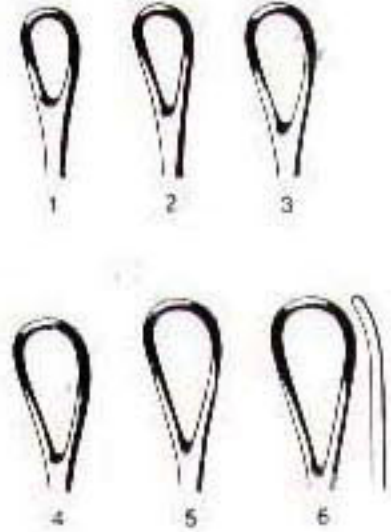

RHEINSTATER
61-910 28cm SHARP
61-920 29cm BLUNT



CHELSEA
61-930 31cm



RANDALL
61-940 24cm



NOVAK
61-950 23cm



SHARMAN
61-960 23cm

MYOMA SCREW



DOYEN
61-970



OBSTETRICS
OBSTETRICAL FORCEPS

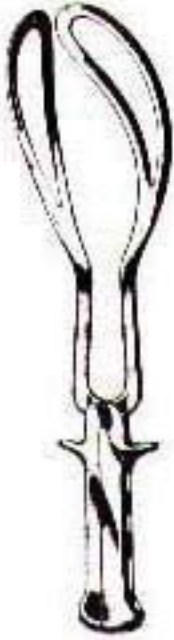

DE-LEE
63-100 39cm



DE-LEE
63-110 38cm



DE-LEE
63-120 30cm



SIMPSON
63-130 30cm



SIMPSON-BRALN
63-140 33cm
63-142 38cm



WRIGLEY
63-150 27cm



KIELLAND
63-160 41cm



ELLIOT
63-170 32cm
63-172 38cm



OBSTETRICS OBSTETRICAL FORCEPS



NAEGELE
63-180 36cm
63-182 40cm



KEDARNATH DAS
63-190 33cm



PIPER
63-200 44cm



BOERMA
63-210 29cm



KIELAND-LUIKART
63-220 40cm



SIMPSON-LUIKART
63-230 36cm



McLEAN
63-240 36cm



McLEAN-TUCKER
63-250 39cm



OBSTETRICS
OBSTETRICAL FORCEPS

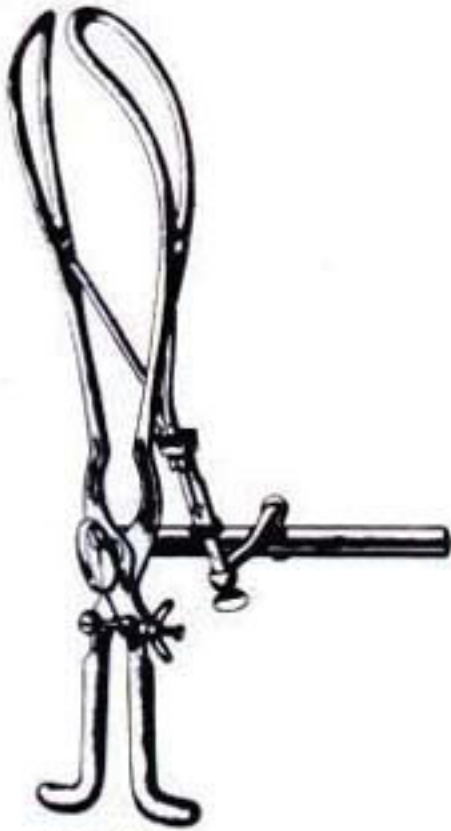

TARNIER
63-260 38cm
63-262 40cm
63-264 42cm

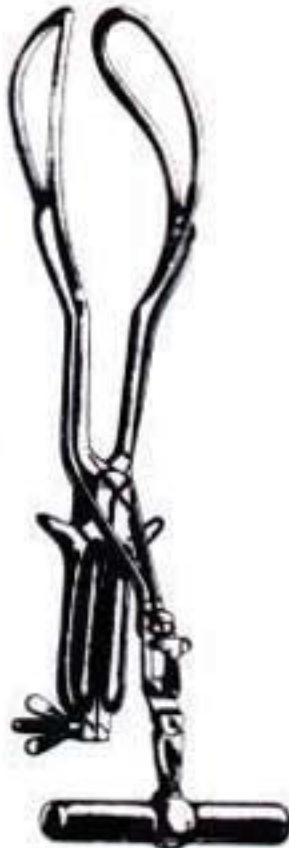

KEDARNATH DAS
63-270 38cm



DEWEY
63-280 37cm

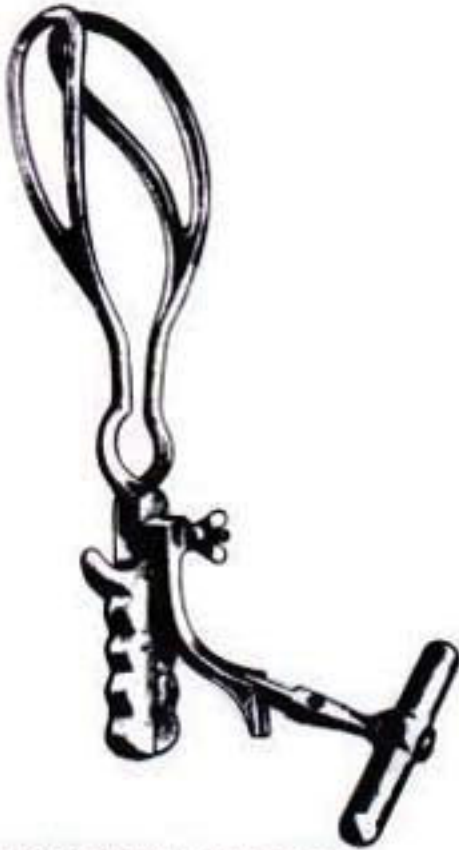

BARNES-NEVILLE-SIMPSON
63-290



BARNES-NEVILLE
63-300

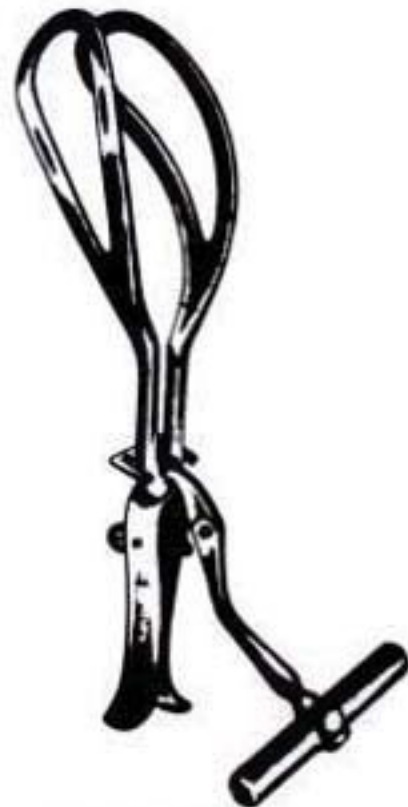

HAIG-FERGUSON
63-310



**OBSTETRICS
CRANIOCLAST**



MILNE-MURRAY
63-320



WINTER
63-330



AUVARD-ZWEIFEL
63-340 46cm

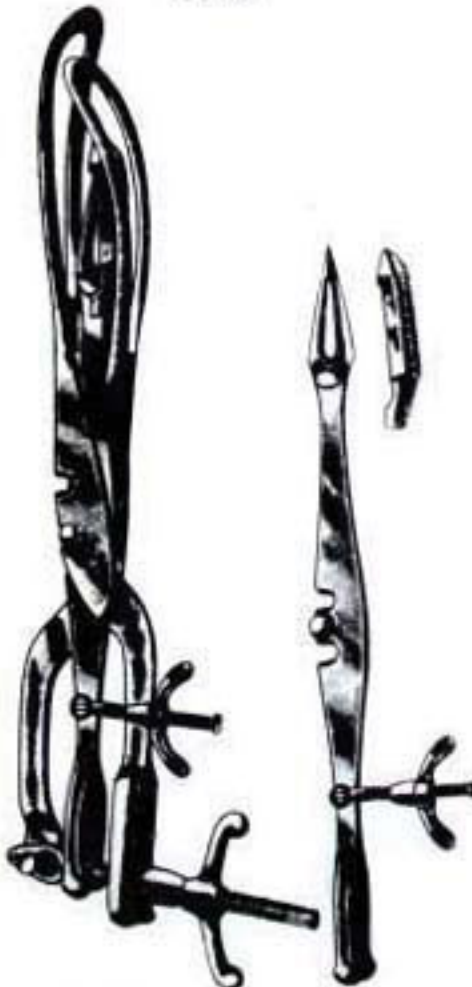

TARNIER
63-350 46cm



BRAUN
63-360 42cm



OBSTETRICS

PERFORATORS



SIMPSON
63-370 30cm



NAEGELE
63-380 25cm



SMELLIE
63-390 25cm

HOOKS



SMELLIE
63-400 33cm



BRAUN
63-410 30cm

HOOKS



63-420 26cm



TARGETT
63-430 39cm

PELVIMETERS



MARTIN
63-440 34cm



COLLIN
63-450 35cm



OBSTETRICS

PELVIMETERS



COLLYER
63-460 30cm



BREISKY
63-470 33cm

UMBILICAL CLAMP



KANE
63-480 8.5cm

PLACENTA FORCEPS

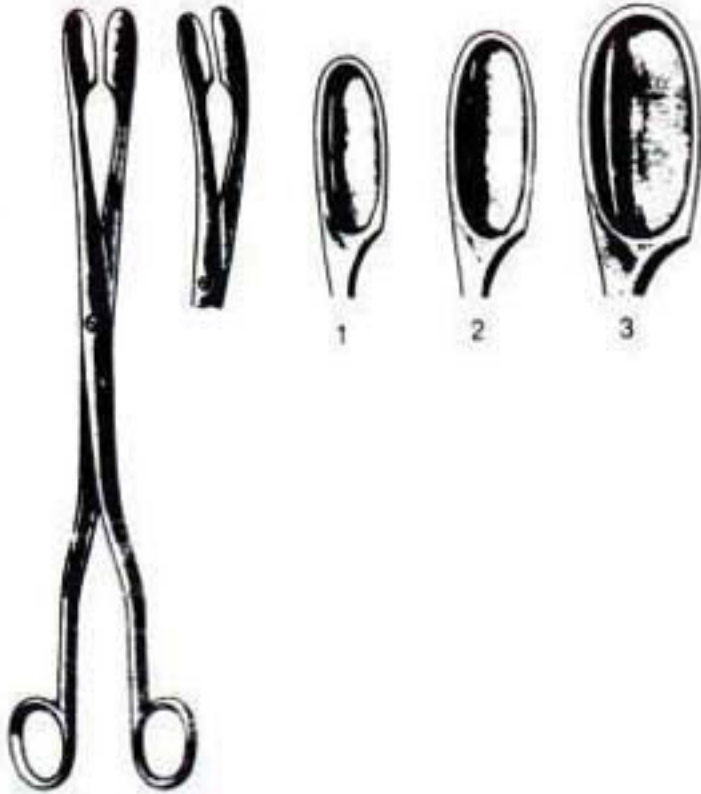

WINTER

| STR | 28cm | CUR |
|--------|-------|--------|
| 63-490 | Fig 1 | 63-500 |
| 63-492 | Fig 2 | 63-502 |
| 63-494 | Fig 3 | 63-504 |

OVUM FORCEPS



HEYWOOD-SMITH
63-510 25.5cm

COREY
63-520 24cm



OBSTETRICS

PLACENTA AND HAEMOSTATIC FORCEPS



SAENGER
63-530 27cm
63-532 27cm



WILLET
63-540 19cm



GREEN-ARMYTAGE
63-550 21cm

CATHETERS AND TUBES



CARTON
63-560 30cm



BOZEMANN-FRITSCH
63-570 8mm \varnothing
63-572 10mm \varnothing
63-574 12mm \varnothing



DREW SMYTHE
63-580



PROVIS
63-590



SPACKMANN
63-600 18cm



STERILIZATION STERILIZING FORCEPS



CHEATLE
65-100 27cm



CHEATLE
65-110 27cm



CHEATLE
65-120 28cm



LONDON PATT
65-130 28cm



HARRISON
65-140 25cm
65-142 30cm
65-144 36cm
65-146 46cm



65-150 20cm
65-152 30cm



DAVIS
65-160 16cm
65-162 20cm
65-164 24cm

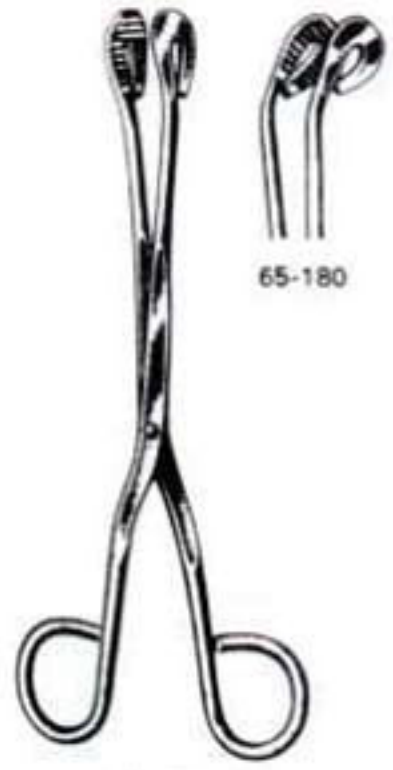

UTILITY
65-170 20cm 65-180
65-172 28cm 65-182



ORTHOPAEDIC

BONE SCREW AND PLATE HOLDING FORCEPS



LANE
67-100 18cm



LANE
67-110 22cm



LANE
67-120 23cm



RADOLF
67-130 13.5cm



DERMATOLOGY

NAIL CUTTERS

CUTICLE



| | |
|-------------|--------|
| STR | EUR |
| 69-100 9cm | 69-110 |
| 69-102 10cm | 69-112 |
| 69-104 11cm | 69-114 |

NAIL

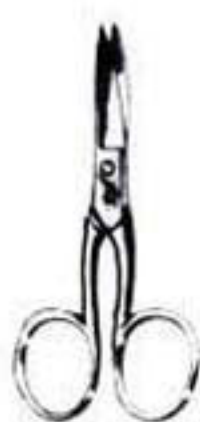

| | |
|-------------|--------|
| STR | CUR |
| 69-120 10cm | 69-130 |



69-140 12cm



| |
|-------------|
| 69-150 14cm |
| 69-152 16cm |



69-160 14cm